

© AIR COMFORT

AIR DISTRIBUTION

AIR MANAGEMENT

ILMAVIRTOJEN MITTAUS- JA SÄÄTÖOPAS

» HUHTIKUU 2015

Sisältö

Käytetyt merkinnät	6
Mittausmenetelmät	6
Mittaus- ja säätöoppaan käyttö	6
Mittausvirheiden arvioiminen	7
Ilman tiheyden vaikutus mittaustuloksiin.....	8

Hajottajat

Kattohajottajat - tuloilma

RHKB, RHOB (ATTC)	9
RPPA, ROPA (ATTC)	9
ROFB, RPFB.....	10
KHAA+ATTC.....	10
CTPB	11

Kattohajottajat - pyörre

VFKB (ATTC)	12
VSKB (ATTC)	12
NWPP+ATTC.....	13
ODZA+ATTC	13

Kattohajottajat - suutin

DYCC, DYKC (ATTC)	14
DYRB	14
DYFB	15
DYSC.....	15
DYBA	16

Seinähajottajat

DYVB	16
KHDA + ATTC	17
SVQC.....	17

Piennopeuslaitteet

DVHA.....	18
DVQA	18
DVRA.....	18
DVPA	19
DVCA.....	19
PNAA.....	19

Lattiahajottajat

GFB, DASH, DUSH	20
PWAA	21

Suihkusuutinhajottajat

DD, DK, DKO, DS, DR	21
---------------------------	----

Hajottajat joissa HEPA-suodatin

SPNH, SPNV	22
SPWH, SPWV.....	22
NSLA.....	22

Poistoilmahajottajat

HPKB	23
RPPE, ROPE	24
EHC.....	25

Venttiilit

Tuloilmaventtiilit

KE	26
KTS.....	29
KTI.....	31
STQA.....	35

STI.....	36
CTVB.....	40
CTVK.....	41

Poistoilmaventtiilit

EHI.....	41
KK.....	42
KSO, KSOE, KSOV.....	45
KSOM.....	47
KSOS.....	48
KGEA, KGEB-1.....	49
KGEB.....	50
KGFC.....	52
BYBA.....	53
BYFA.....	53

Korvausilmaventtiilit

KIV.....	54
----------	----

Säleiköt

TG, TGE.....	55
SV, AVS.....	55
USR.....	55

Suutinkanavajärjestelmät

Activent.....	56
UNO.....	56

Jäähdytyspalkit

IQFF STELLA.....	57
IQIF WEGA.....	58
IQFD/IQFE.....	59
IQID.....	61
IQFC.....	62

IQSA.....	63
IQTA.....	64
QPSA.....	65
IQCA.....	66

Ilmavirtasäätimet

EMA(S,E).....	67
EMS(S,D).....	67
EMSF.....	67
EHA(S,E).....	67
EHS(S,D).....	67
EHSF.....	67
HVSA.....	67
EMA(S,E), EMS(S,D) EHA(S,E), EHS(S,D) arvojen asettelu.....	68
EMPA, EMPD arvojen asettelu.....	70

Mittaus- ja säätölaitteet

IRIS.....	72
MR.....	79

Vanhat tuotteet

CTAA.....	80
CTBA.....	80
CTCA.....	81
CTBA/CTCA DTTZ/CTTZ-laatikolla.....	81
Muut laitteet joissa säätö tasauslaatikossa CTTZ.....	82
CTF(A,B,J).....	82
CTKA.....	83
CTPB + ATTA.....	84

CTPB + ATTB	84	STH	105
CYLD.....	85	SVB säätöarulla	106
CYLP, CYLO	85	SVE	106
DAAD, DAAP	86	SVQ	107
DCKA.....	86	SVQ säätöarulla.....	107
DS(K,R)S, DS(K,R)F	87	TG	108
DV(K,R)F, DV(K,R)S.....	87	VFFA	109
DYCB, DYKB	88	VFKA	110
DYCC, DYKC (ATTB).....	88	VFKB (ATTB)	110
DYFA.....	89	VFSA	111
DYKA, DYCA	89	VSKA	111
DYK(C,K)	90	VSFA	112
DYSA.....	90	VSKB (ATTB)	113
DYSB	91	VSSA	113
DYVA	91	Varimix	
Floormaster FM-90.....	92	ATTA/ATFA tasauslaatikolla.....	114
GPD.010.....	93	Varimix	
HPKA	93	tasauslaatikollax DTTZ	115
HPSA.....	94	Varimix, mittaus laitteessa	
KH	94	(CTDA, CTDB, CTEA, CTEB).....	116
KH + ATTB	95	EHOS, EHOE	117
KHD + ATTB	95	EMAS, EMAE	117
KS.....	96	EMOS, EMOE	117
KSO-M, KSO-MH.....	97	EMSF	117
KSOP	98	EMSS, EMSD.....	117
KVM.....	99	EMSM, EM(J,P) (B,C),	
NWPPlus	99	EMJT, EMJF	118
RHKB, RHOB (ATTB).....	100	EHCA, EHCb.....	119
RHU	100	IQIB, IQIC.....	120
ROFA, RPFA	101	QTSB, QTSS.....	121
ROKA, RPKA	101	IRIS-M	122
RORB, RPRB	102	MRS.....	126
ROSA, RPSA	102		
RSKO, RSKP	103		
RSRO, RSRP	103		
SDZA.....	104		
SE.....	104		

Käytetyt merkinnät

Tunnus	Suureen nimi	Yksikkö
q_v	ilmavirta	l/s, m ³ /s, m ³ /h
Δp_m	mittauspaine-ero	Pa
k	k-kerroin ($q_v = k \times \sqrt{\Delta p_m}$)	
D, d	halkaisija	mm
a, s	rako, asento, avaus	mm
L	suojaetäisyys häiriölähteeseen	m
n	suojaetäisyyskerroin	-
m_2	mittausmenetelmän epätarkkuus (menetelmävirhe)	%
ρ_t	ilman tiheys mittaushetkellä	kg/m ³

Mittausmenetelmät

1. Paine-eron (Δp_m) mittaus kalibroiduista venttiileistä mittasondilla (KSO, KTS, STQA...).
Säätö tapahtuu venttiilin avausta (a) tai reikien lukumäärää muuttamalla.
2. Paine-eron (Δp_m) mittaus kiinteällä, kalibroidulla anturilla varustetusta tulo-/poistoilmalaitteesta (RHKP, SVQC...).
Säätö tapahtuu laitteessa olevien säätönarujen avulla säätöpellin asentoa muuttamalla, poistoilmalaitteessa EHC rakoa säätämällä.
3. Paine-eron (Δp_m) mittaus kiinteällä, kalibroidulla anturilla varustetusta tulo-/poistoilmalaitteesta (DVHA, DVQA...).
Säätö tapahtuu erillisellä säätölaitteella.
4. Paine-eron (Δp_m) mittaus kanavaan asennetuista kiinteistä mittalaitteista (IRIS).
5. Paine-eron (Δp_m) mittaus Optivent- pääteyksiköistä.
Säätö tapahtuu erillisen ohjeen mukaisesti.

Mitta- ja säätöoppaan käyttö

Opas sisältää Fläkt Woods Oy:n vakiotuotteiden k-kertoimet (tarvittaessa tuotteista löytyvät tiedot myös käyrästä-muodossa.)

Oppaassa on kunkin tuotteen kohdalla annettu tiedot poikkeuksellisista suojaetäisyyksistä, korjauskertoimista sekä mitta- ja säätötoimista

Tuotekohtaiset heittokuvio-, ääni-, yms. tiedot löytyvät Fläkt Woods Oy:n tuotekansioista 3 ja 4.

k-kerroin on määritelty ilmavirran yksiköllä l/s

$$q_v = k \times \sqrt{\Delta p_m} \quad \Delta p_m = (q_v / k)^2$$

Muita ilmavirran yksiköitä käytettäessä tehdään korjaus seuraavasti:

$$m^3/s: \quad q_v = 0.001 \times k \sqrt{\Delta p_m} \quad \Delta p_m = (q_v / (0.001 \times k))^2$$

$$m^3/h: \quad q_v = 3.6 \times k \sqrt{\Delta p_m} \quad \Delta p_m = (q_v / (3.6 \times k))^2$$

Esimerkki:

SVQ-125, etulevyn asento s=+30, on säädettävä niin, että ilmavirta $q_v = 50$ l/s

- luetaan k-kerroin sivulta 88
- sijoitetaan $k = 13,0$ mittauspaine-eron kaavaan, jolloin saadaan mittauspaine-eroksi

$$\Delta p_m = (50 / 13,0)^2 = 15 \text{ Pa}$$

- säädetään säätöpeltiä, kunnes haluttu mittauspaine-ero on saavutettu

Mittausvirheiden arvioiminen

$$m = \pm \sqrt{c_1^2 m_1^2 + c_2^2 m_2^2 + c_3^2 m_3^2 + \dots + c_n^2 m_n^2}$$

m mittaus tuloksen suhteellinen epätarkkuus %

m_1 mittausvälineen epätarkkuus (laitevirhe) %

m^2 mittausmenetelmän epätarkkuus (menetelmävirhe) %

m_3 mittarin lukemaepätarkkuus (havaitsemisvirhe) %

m_n muut mahdolliset epätarkkuudet %

$c_{1...n}$ kertoimet, joilla otetaan huomioon erillisten epätarkkuuksien vaikutus lopputulokseen. Kaava huomioi satunnaisvirheiden ja pienten vaikutussuunnaltaan tuntemattomien, systemaattisten virheiden vaikutuksen. Muihin verrattuna pienet virheprosentit voidaan jättää huomiotta, koska niiden vaikutus m :n arvoon on merkityksetön.

Esimerkki kokonaisvirheen arvioinnista:

$m_1 = \pm 4 \%$ (tieto mittarin valmistajalta)

$c_1 = 1/2$ (paine-eron mittaus, $q_V = k \times \sqrt{\Delta p m}$ *)

m_2 riippuu mittausmenetelmästä ja asennustavasta

$c_2 = 1$

$m_3 = 4 \%$ (riippuu käytettävästä mittarista ja painealueesta)

$c_3 = 1/2$ (paine-eron mittaus) *)

*) esim. 10 %:n virhe mittauspaine-erossa vaikuttaa ilmavirtaan n. 5 %.

$$m = \pm \sqrt{(1/2)^2 \times 4^2 + 1 \times m_2^2 + (1/2)^2 \times 4^2} = \pm \sqrt{8 + m_2^2}$$

Antamalla menetelmävirheelle m_2 erilaisia arvoja, saadaan seuraava taulukko:

$m_2 =$	5	7	10	12	15	20	%
$m =$	5.8	7.6	10.4	12.3	15.3	20.2	%

Ilman tiheyden vaikutus mittaustuloksiin

Oppaassa esitetyt k-arvot pätevät normaaliolosuhteissa (20 °C ja 101,3 kPa).

Jos mittausolosuhteet poikkeavat näistä arvoista, saadaan todellinen ilmavirta (q_{Vt}) k-kertoimen avulla lasketusta ilmavirrasta (q_V) seuraavasti:

$$q_{Vt} = q_V \times \sqrt{[1,2 / \rho_t]}$$

RHKB, RHOB (RHKH, RHOH + ATTC)

10/2011 lähtien

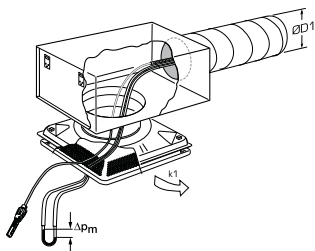

ØD1	ØØD1	1-7ØD1	>7ØD1
100	6,0	6,3	5,9
125	10,1	10,6	10,1
160	17,1	19,9	17,3
200	27,0	30,8	27,9
250	47,1	48,8	39,9
315	65,9	67,2	64,1

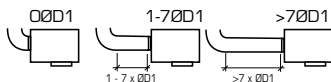

RPPA, ROPA (RPPH, ROPH + ATTC)

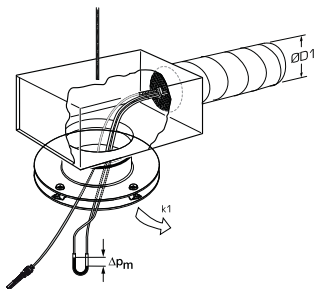

ØD1	ØØD1	1-7ØD1	>7ØD1
100	6,0	6,3	5,9
125	10,1	10,6	10,1
160	17,1	19,9	17,3
200	27,0	30,8	27,9
250	47,1	48,8	39,9
315	65,9	67,2	64,1

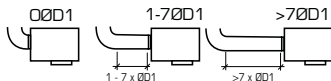

ROFB, RPFB

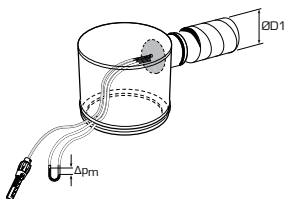

ØD1	0ØD1	1-7ØD1	>7ØD1
100	6,0	6,3	5,9
125	10,1	10,6	10,1
160	17,1	19,9	17,3
200	27,0	30,8	27,9
250	47,1	48,8	39,9
315	65,9	67,2	64,1
400	ks. IRIS-400, s. 68		

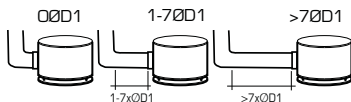

KHAA + ATTC

10/2011 lähtien

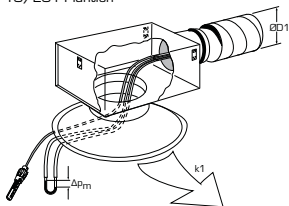

ØD1	0ØD1	1-7ØD1	>7ØD1
100	6,0	6,3	5,9
125	10,1	10,6	10,1
160	17,1	19,9	17,3
200	27,0	30,8	27,9
250	47,1	48,8	39,9
315	65,9	67,2	64,1

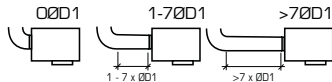
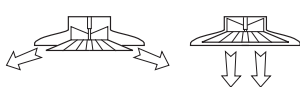

CTPB

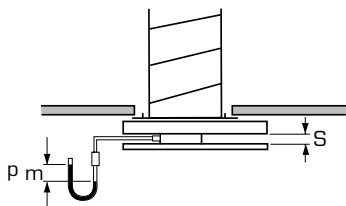

CTPB	s, mm	20	25	30	35
125	k	5,7	6,3	6,9	7,6
CTPB	s, mm	25	30	35	40
160	k	8,8	9,3	10,5	11,4

CTPB + ATTC

10/2011 lähtien

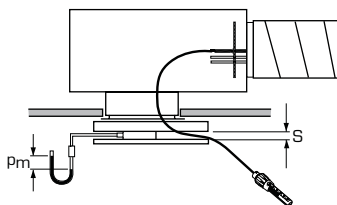

ØD1	0ØD1	1-7ØD1	>7ØD1
125	10,1	10,6	10,1
160	17,1	19,9	17,3

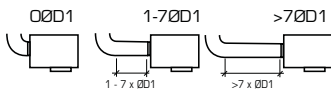

VFKB (VFKH + ATTC)

10/2011 lähtien

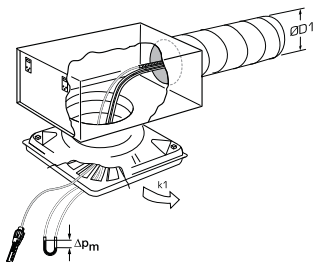

ØD1	0ØD1	1-7ØD1	>7ØD1
160	17,1	19,9	17,3
200	27,0	30,8	27,9
250	47,1	48,8	39,9
315	65,9	67,2	64,1

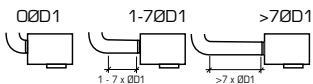

VSKB (VSKH + ATTC)

10/2011 lähtien

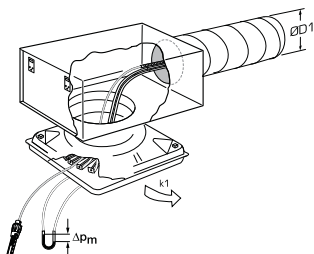

ØD1	0ØD1	1-7ØD1	>7ØD1
100	6,0	6,3	5,9
125	10,1	10,6	10,1
160	17,1	19,9	17,3
200	27,0	30,8	27,9
250	47,1	48,8	39,9
315	65,9	67,2	64,1

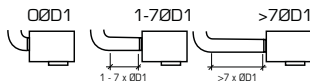

NWPP + ATTC

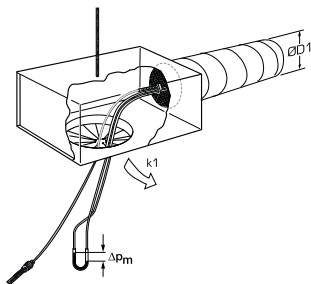

$\varnothing D1$	$0\varnothing D1$	$1-7\varnothing D1$	$>7\varnothing D1$
125	10,1	10,6	10,1
160	17,1	19,9	17,3
200	27,0	30,8	27,9
250	47,1	48,8	39,9
315	65,9	67,2	64,1

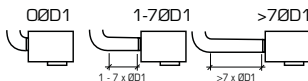

ODZA + ATTC

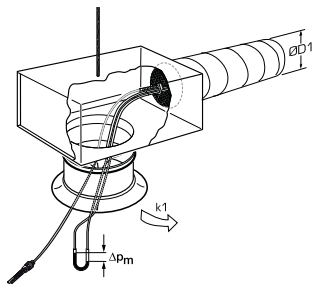

$\varnothing D1$	$0\varnothing D1$	$1-7\varnothing D1$	$>7\varnothing D1$
200	27,0	30,8	27,9
250	47,1	48,8	39,9
315	65,9	67,2	64,1

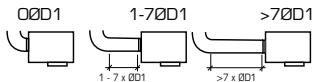

DYCC, DYKC (DYCH, DYKH + ATTC)

10/2011 lähtien

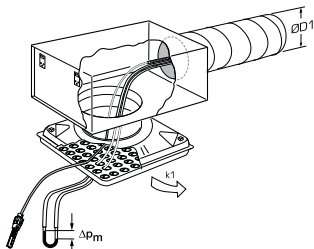

ØD1	0ØD1	1-7ØD1	>7ØD1
100	6,0	6,3	5,9
125	10,1	10,6	10,1
160	17,1	19,9	17,3
200	27,0	30,8	27,9
250	47,1	48,8	39,9
315	65,9	67,2	64,1

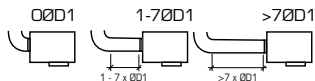

DYRB (DYRH + ATTC)

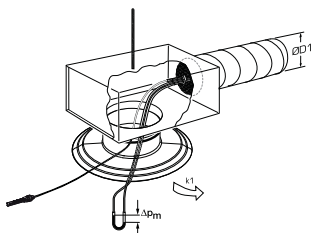

ØD1	0ØD1	1-7ØD1	>7ØD1
100	6,0	6,3	5,9
125	10,1	10,6	10,1
160	17,1	19,9	17,3
200	27,0	30,8	27,9
250	47,1	48,8	39,9
315	65,9	67,2	64,1

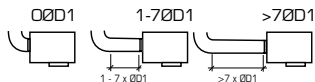

DYFB

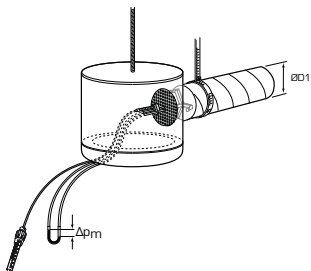

ØD1	0ØD1	1-7ØD1	>7ØD1
100	6,0	6,3	5,9
125	10,1	10,6	10,1
160	17,1	19,9	17,3
200	27,0	30,8	27,9
250	47,1	48,8	39,9
315	65,9	67,2	64,1
400	ks. IRIS-400, s. 68		

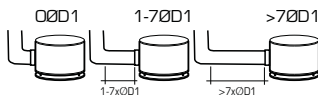

DYSC (DYSH + ATTC)

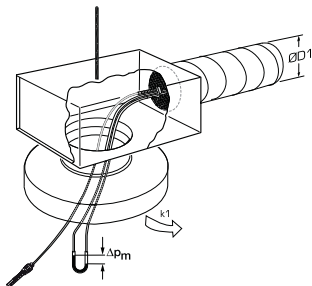

ØD1	0ØD1	1-7ØD1	>7ØD1
100	6,0	6,3	5,9
125	10,1	10,6	10,1
160	17,1	19,9	17,3
200	27,0	30,8	27,9
250	47,1	48,8	39,9
315	65,9	67,2	64,1

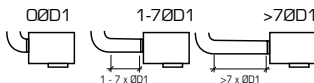

DYBA (DYBH + ATTC)

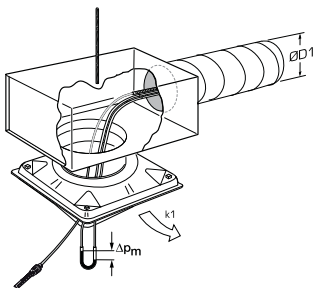

ØD1	0ØD1	1-7ØD1	>7ØD1
100	6,0	6,3	5,9
125	10,1	10,6	10,1
160	17,1	19,9	17,3
200	27,0	30,8	27,9
250	47,1	48,8	39,9
315	65,9	67,2	64,1

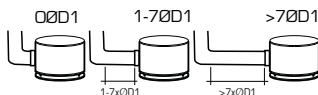

DYVB

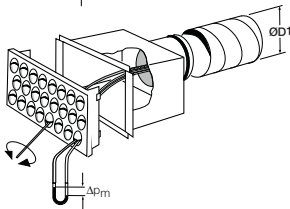
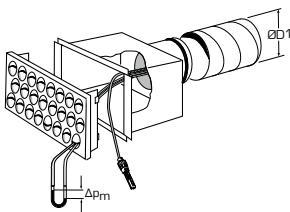

10/2011 lähtien

ØD1	k1	k2	k3
100	6,0	6,3	5,9
125	10,1	10,6	10,1
160	17,1	19,9	17,3
200	27,0	30,8	27,9

ennen 10/2011

ØD1	k1	k2	k3
100	6,7	7,0	6,3
125	10,6	11,7	10,7
160	17,6	20,0	18,5
200	26,9	31,6	29,2

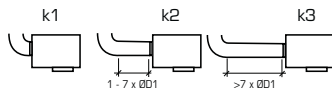

KHDA + ATTC

10/2011 lähtien

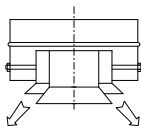
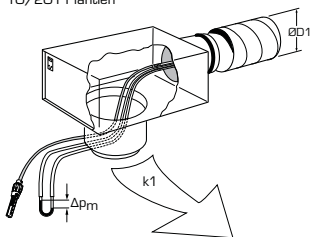

Ø200-Ø250

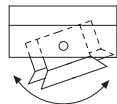

ØØD1

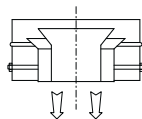

Ø315-Ø500

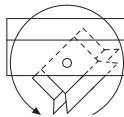

>7ØD1



KHDA	ØD1	ØØD1	1-7ØD1	>7ØD1
200	160	17,1	19,9	17,3
250	200	27,0	30,8	27,9
315	250	47,1	48,8	39,9
400	315	65,9	67,2	64,1
500	-	-	-	-

1 - 7 x ØD1

>7 x ØD1

SVQC

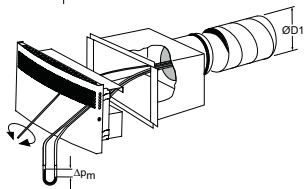
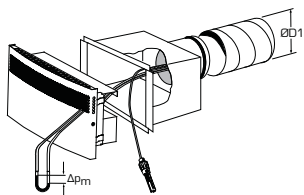

10/2011 lähtien

ØD1	k1	k2	k3
100	6,0	6,3	5,9
125	10,1	10,6	10,1
160	17,1	19,9	17,3
200	27,0	30,8	27,9

ennen 10/2011

ØD1	k1	k2	k3
100	6,7	7,0	6,3
125	10,6	11,7	10,7
160	17,6	20,0	18,5
200	26,9	31,6	29,2

k1

k2

k3

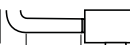

1 - 7 x ØD1

>7 x ØD1

DVHA

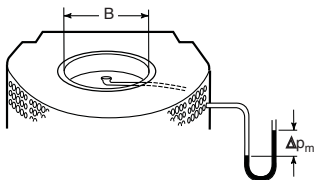

B	k
100	8
125	13
160	21
200	38
250	53
315	89
400	132
500	208

DVQA

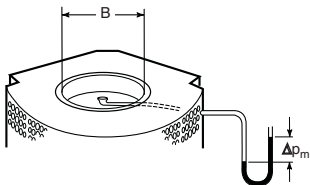

B	k
100	8
125	13
160	20
200	34
250	52
315	85
400	138

DVRA

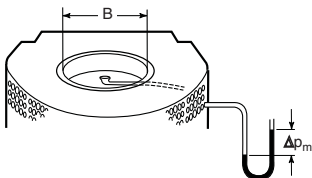

B	k
125	13
160	21
250	58
315	83
400	134
630	332

DVPA

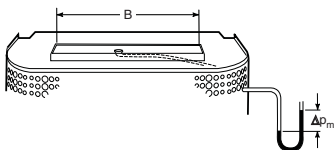

B	k
300	16
400	41
700	113
1200	264
1300	440

DVCA

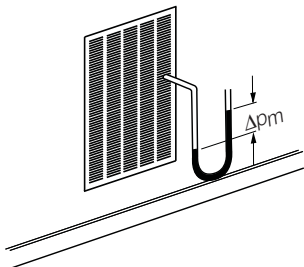

DVCA	k
300-60	17
400-80	22

PNAA

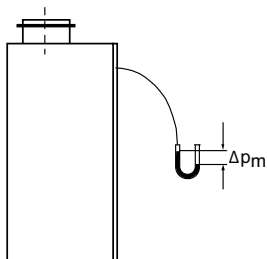

PNAA	Narujen väri		
	Sulkeva	Avaava	k
160	Oranssi-valkoinen	Valkoinen	28
200	Sininen-valkoinen	Valkoinen	57
250	Vihreä-valkoinen	Valkoinen	77
315	Musta	Valkoinen	98
400	Musta	Valkoinen	176

GFB, DASH, DUSH

DUSH

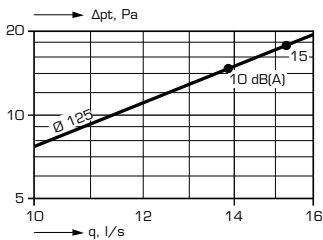

DASH

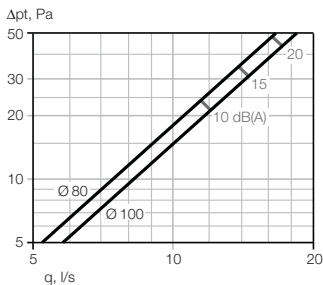

GFB

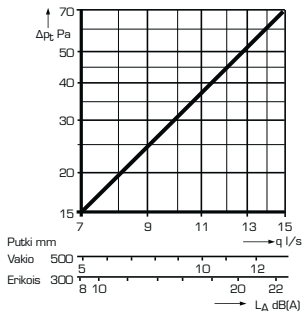

PWAA



Ilmavirta säädetään kanavapellillä.

DD, DK, DKOA, DR, DS



Ilmavirta säädetään kanavapellillä.



SPNH, SPNV

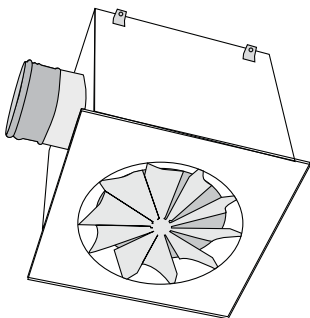

Ilmavirta säädetään pellillä ja mittanipalla.

SPWH, SPWV

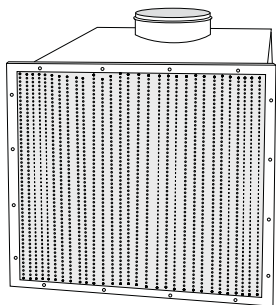

Ilmavirta säädetään pellillä ja mittanipalla.

NSLA

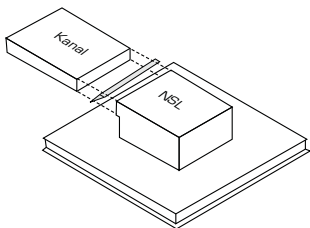

Ilmavirta säädetään pellillä ja mittanipalla.

HPKB (HPKH + ATTC)

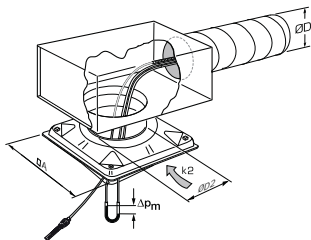

ØD2	A	k2 0 mm	k2 12 mm
160	425	13,0	16,6
160	595	14,4	16,0
200	425	16,1	25,0
200	595	20,4	24,4
250	595	25,6	31,5
315	595	33,1	43,2
400	595	41,2	63,8

RPPE, ROPE (RPPH, ROPH + ATTC)

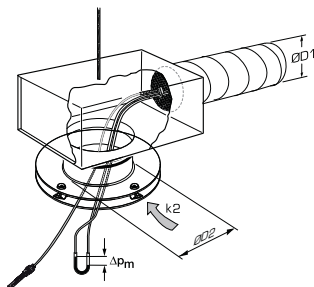

ØD1	ØD2	k2 25 mm	k2 40 mm
100	125	7,9	9,3
125	160	10,6	13,0
160	200	14,0	17,5
200	250	20,1	25,5
250	315	27,4	38,9
315	400	32,5	47,0

ØD1	ØD2	k2 25 mm	k2 40 mm
100	125	8,6	10,3
125	160	12,3	15,0
160	200	16,0	21,4
200	250	24,8	33,8
250	315	31,8	46,4
315	400	39,0	59,6

ØD1	ØD2	k2 25 mm	k2 40 mm
100	160	10,8	12,8
125	200	14,6	18,1
160	250	20,6	24,9
200	315	30,6	45,5
250	400	35,9	51,7

ØD1	ØD2	k2 25 mm	k2 40 mm
100	160	12,8	16,3
125	200	16,5	23,0
160	250	23,9	32,7
200	315	34,8	54,3
250	400	39,8	61,0

EHC

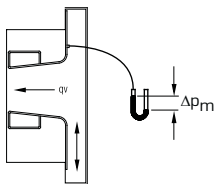

a	k		
	300x150	500x150	800x150
0	1,9	3,5	6,0
1	2,6	5,8	10,8
2	4,0	8,5	14,6
3	5,7	11,2	19,0
4	7,1	14,0	23,9
5	8,9	16,4	28,3
6	10,8	19,0	32,9
7	12,4	21,0	35,4

EHC-300x150

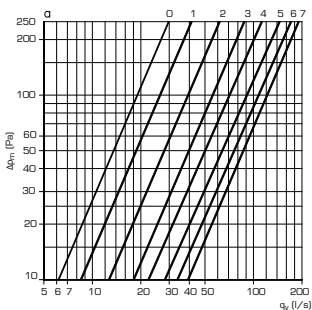

EHC-500x150

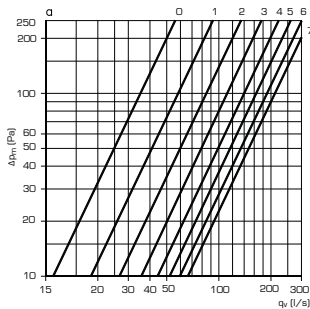

EHC-800x150

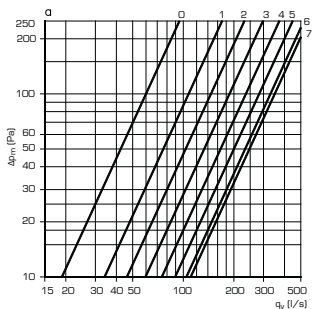

KE

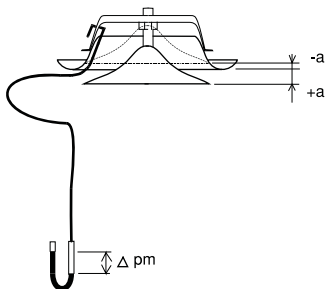

a	-3	-2	0	3	6	9
ø80	0,3	0,5	0,9	1,6	2,3	2,8

a	-3	-2	0	2	4	6	8	10
ø100	0,5	0,7	1,2	1,8	2,5	3,2	4,1	4,9
9.1.06 →	0,6	0,9	1,4	1,9	2,5	3,0	3,6	4,1

a	-7	-3	0	3	6	9	12	15
ø125	1,6	2,4	3,0	4,1	5,3	6,8	8,7	10,0
9.1.06 →	1,0	2,2	3,2	4,2	5,2	6,2	7,2	8,2

a	-5	-3	0	3	6	10	15
ø150	2,3	3,0	4,2	5,7	7,4	9,9	12,0
9.1.06 →	2,2	3,0	4,2	5,4	6,6	8,4	10,3

a	-10	-5	0	5	10	15
ø160	1,4	2,7	4,4	6,9	9,9	14,0
9.1.06 →	1,0	2,7	4,4	6,2	7,8	9,5

a	-3	0	3	6	9	12	15	20
ø200	1,5	3,0	4,7	6,6	8,8	11,1	13,5	17,3
13.2.06 →	1,4	3,4	5,4	7,4	9,4	11,2	13,2	16,6

KE-80-C

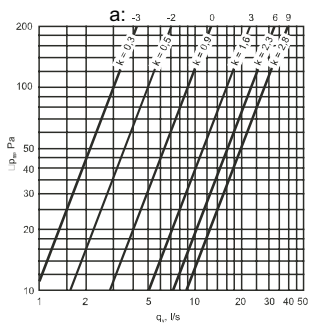

KE-100-C

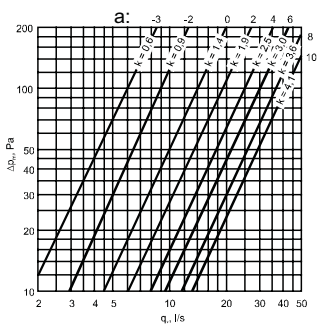

KE-125-C

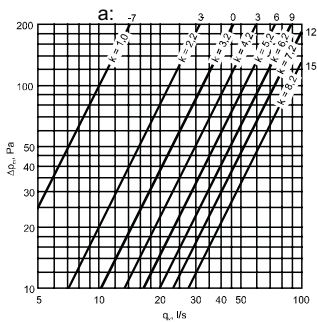

KE-150-C

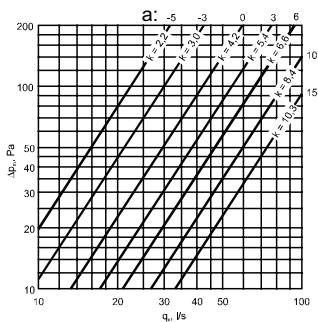

KE-160-C

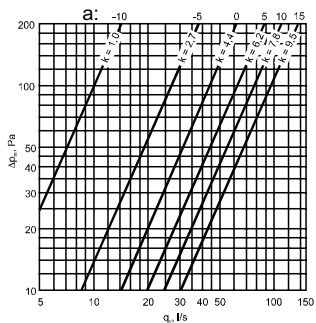

KE-200-C

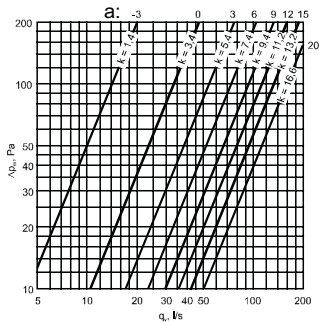

KTS

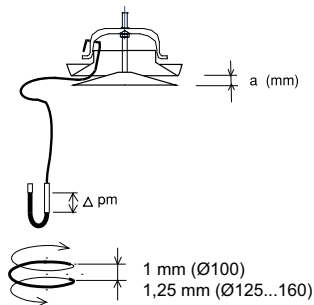

KTS-100-C			
a (mm)	06,2006		
2	0,9	1,0	1,1
4	1,5	1,6	2,0
6	1,9	2,3	2,7
9	2,3	2,9	4,0
12	2,8	3,3	5,1
15	3,3	3,6	-

KTS-125-C			
a (mm)	06,2006		
4	2,0	1,9	2,2
6	2,6	2,6	3,1
9	3,3	3,4	4,2
12	3,8	4,1	5,5
15	4,4	4,4	7,0

KTS-160-C			
a (mm)	06,2006		
4	2,7	2,3	3,0
6	3,4	3,3	4,2
10	4,8	4,5	6,4
15	5,8	6,4	8,9
20	7,0	7,2	11,2

KTS-100-C

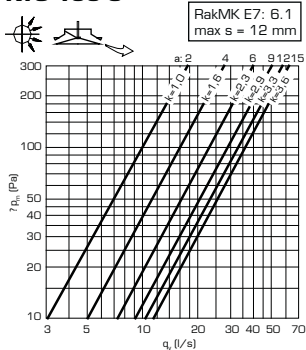

KTS-125-C

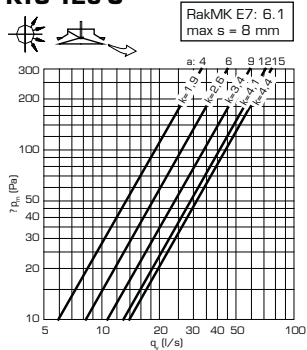

KTS-160-C

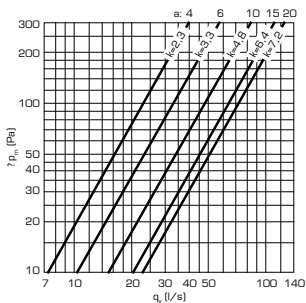
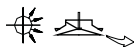

KTS-100-C

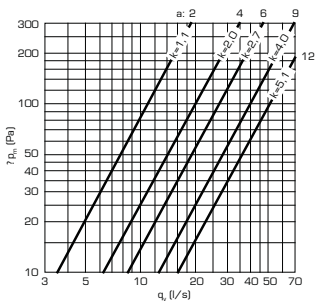
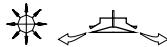

KTS-125-C

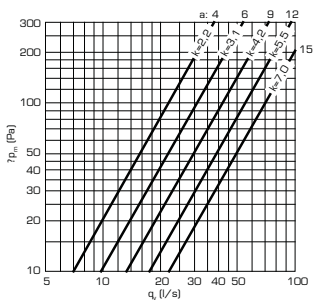
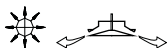

KTS-160-C

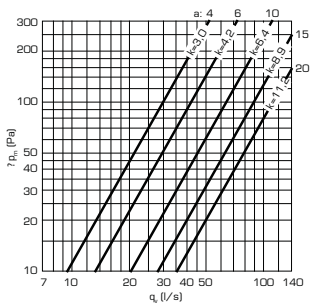
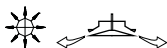

KTI

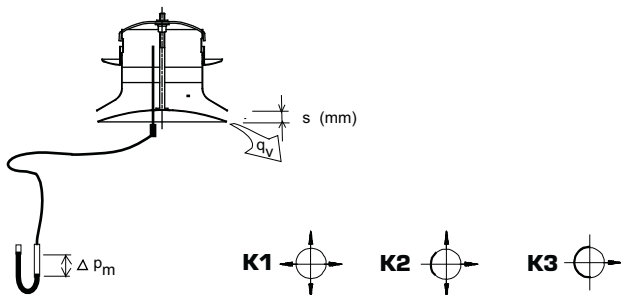

KTI-100-C

s (mm)	k1	k2	k3
2	1,0	1,1	0,8
3	1,6	1,5	1,1
4	2,0	1,8	1,4
6	3,0	2,5	1,7
8	3,8	3,2	2,2
10	4,8	3,9	2,6
12	5,6	4,2	3,0
16	-	-	3,6

KTI-125-C

s (mm)	k1	k2	k3
2	0,7	1,0	0,8
3	1,1	1,6	1,1
4	2,0	1,9	1,5
6	3,4	2,8	2,1
8	4,8	3,8	2,7
10	6,0	4,7	3,3
12	7,1	5,5	3,8
16	9,0	7,0	5,0

KTI-160-C

s (mm)	k1	k2	k3
2	1,6	-	-
3	2,4	2,3	1,6
4	3,2	2,7	2,1
6	4,7	3,8	2,9
8	6,3	5,0	3,6
10	7,7	6,1	4,4
12	9,1	7,1	4,9
16	11,8	9,2	6,5
20	14,3	11,2	7,8

KTI-200-C

s (mm)	k1	k2	k3
3	2,9	2,5	1,8
4	3,8	3,0	2,7
6	5,7	4,4	3,6
8	7,4	5,7	4,5
10	9,3	7,1	5,4
12	11,0	8,3	6,4
16	14,6	11,0	8,0
20	17,9	13,5	9,8
25	21,9	16,2	11,7



KTI-100-C

KTIK-100:
max s = 8 mm

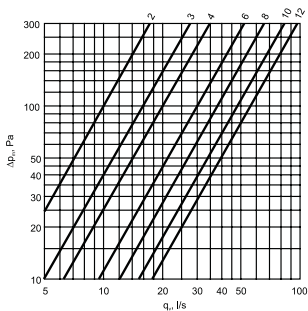

KTI-125-C

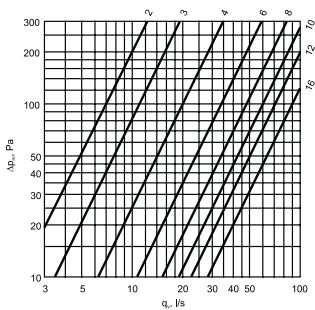

KTI-160-C

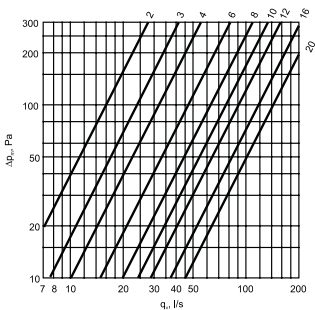

KTI-200-C

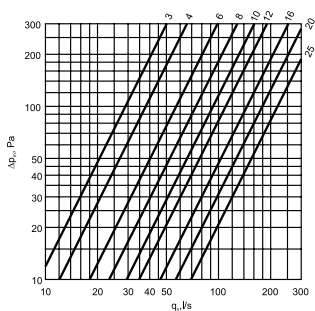



KTI-100-C

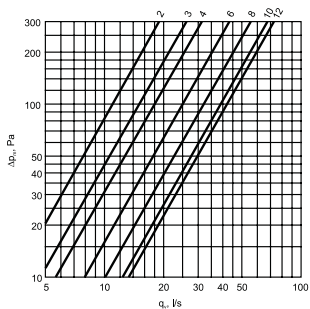

KTI-125-C

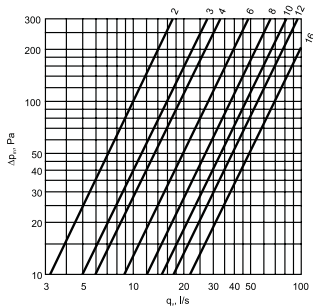

KTI-160-C

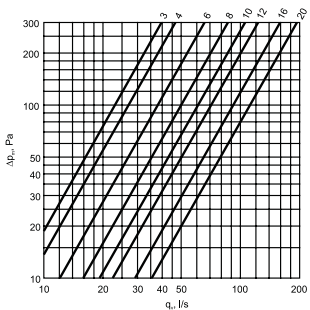

KTI-200-C

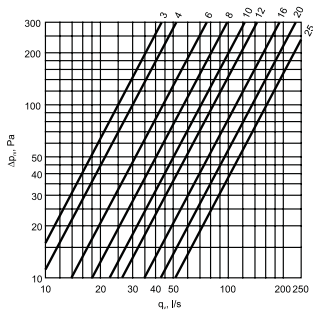



KTI-100-C

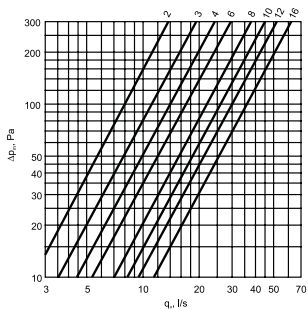

KTI-125-C

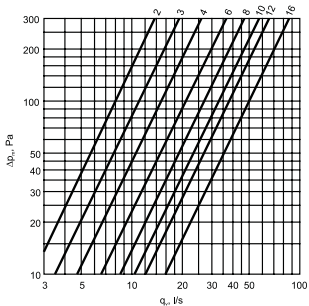

KTI-160-C

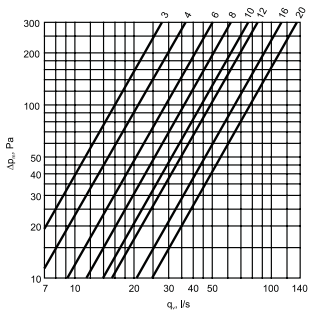

KTI-200-C

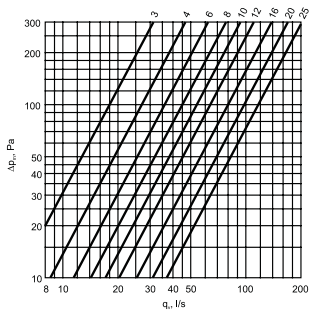

STQA

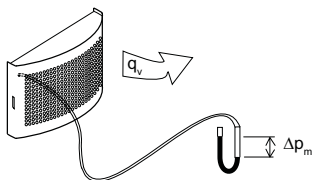

k	
n	100 / 125
2	0,6
3	0,9
4	1,2
5	1,5
6	1,8
7	2,1
8	2,4
9	2,7
10	3,0
11	3,3
12	3,6
13	3,9
14	4,2

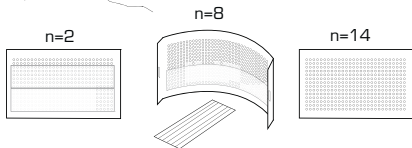

STQA-100-C / STQA-125-C

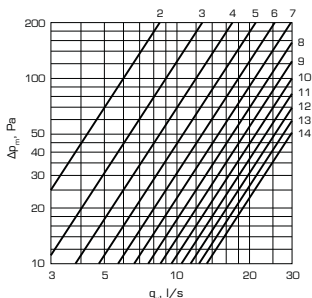

STI

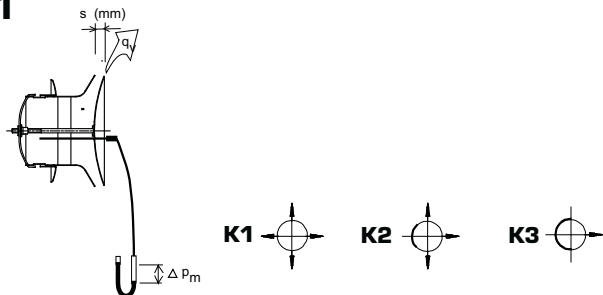

STI-100-C

s (mm)	k1	k2	k3
0	0.6	-	0.6
2	1.6	-	1.6
3	2.1	-	1.8
4	2.7	2.5	2.1
6	3.6	3.3	2.4
8	4.6	4.1	2.9
10	5.6	4.8	3.2
12	6.1	5.3	3.6
16	7.0	6.3	4.3

STI-125-C

s (mm)	k1	k2	k3
0	0.8	-	0.8
2	2.0	-	1.5
3	2.5	-	1.9
4	3.2	2.6	2.2
6	4.4	3.5	2.8
8	5.8	4.4	3.3
10	6.9	5.2	3.9
12	7.8	6.1	4.5
16	10.3	7.8	5.6

STI-160-C

s (mm)	k1	k2	k3
0	1.0	-	1.0
2	2.1	-	2.1
3	2.7	-	2.6
4	3.6	3.3	3.1
6	5.0	4.2	4.1
8	6.5	5.5	4.9
10	8.1	6.6	5.6
12	9.6	7.7	6.5
16	12.7	9.9	7.7

STI-200-C

s (mm)	k1	k2	k3
0	1.8	-	1.8
2	3.0	-	3.0
3	3.4	-	3.2
4	4.7	3.9	3.8
6	6.7	5.3	4.9
8	8.5	6.9	6.3
10	10.0	8.4	7.5
12	12.2	9.7	8.5
16	16.1	12.3	10.3
20	19.4	14.9	12.1
25	23.3	17.8	14.6



STI-100-C

STIK-100:
max s = 6 mm

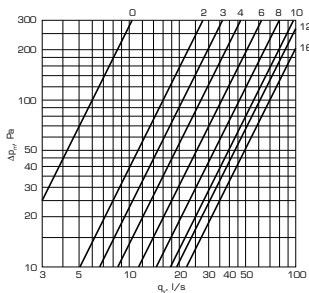

STI-125-C

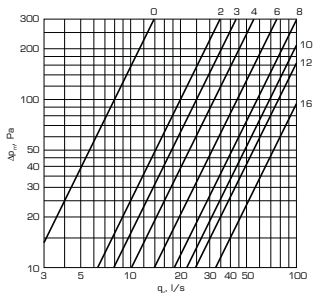

STI-160-C

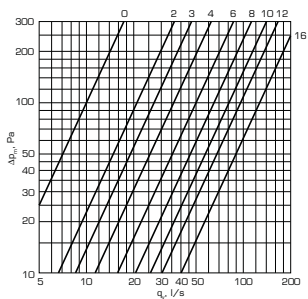

STI-200-C

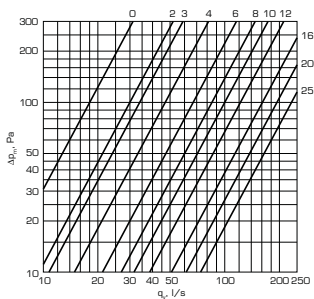



STI-100-C

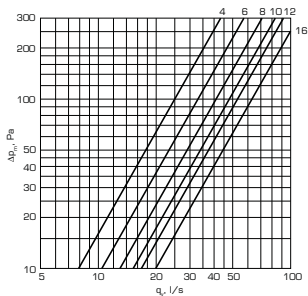

STI-125-C

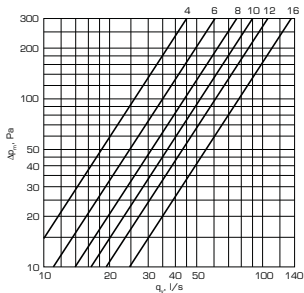

STI-160-C

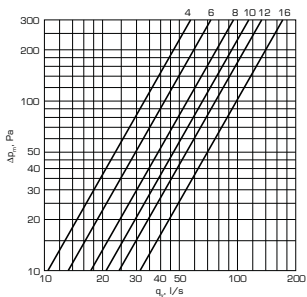

STI-200-C

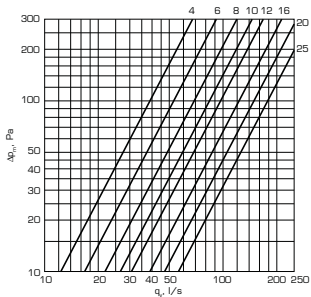



STI-100-C

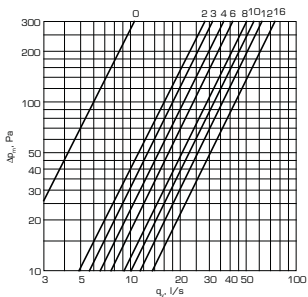

STI-125-C

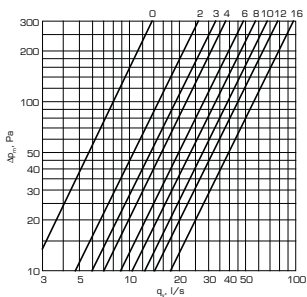

STI-160-C

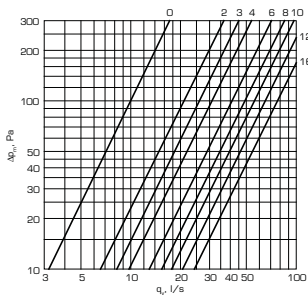

STI-200-C

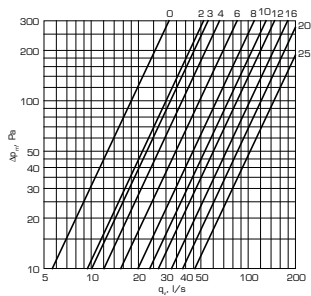

CTVB

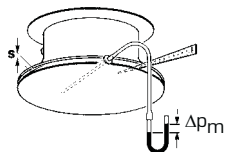

s	3	4	5	6	7	8	10	12	16	20
100	0,9	1,2	1,4	1,7	1,9	2,1	2,6	3,1	4,1	-
125	-	2,0	2,3	2,6	3,0	3,3	4,0	4,7	6,0	-
160	-	-	2,6	3,1	3,5	3,9	4,6	5,4	6,9	8,3

CTVB-100-C

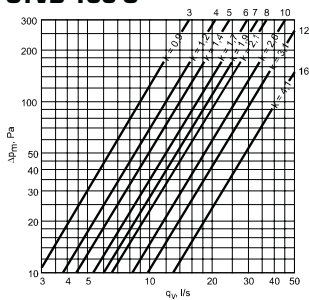

CTVB-125-C

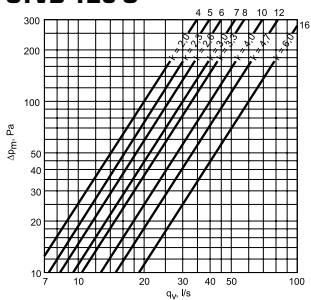

CTVB-160-C

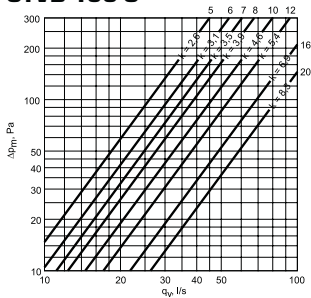

CTVK

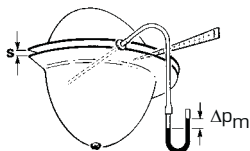

s	2	3	4	5	6	8	10	12	15
100 / 125	0,48	0,71	0,94	1,2	1,4	1,8	2,2	2,7	3,3

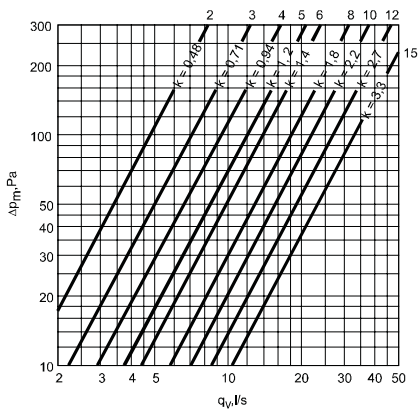

EHI

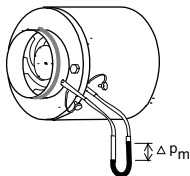

a (mm)	1	2	3	4	5	6	7	8
315	118,0	70,0	58,7	45,1	37,0	30,0	21,8	15,8
400	131,0	102,0	88,3	67,3	52,7	38,5	28,4	15,5

KK

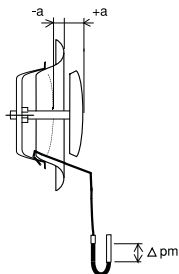

a	-12	-10	-6	-3	0	3	6	9
ø80	0,3	0,5	0,8	1,1	1,3	1,6	1,9	2,1

a	-10	-8	-5	0	5	10
ø100	0,5	0,7	1,0	1,7	2,3	2,9
9.1.2006 →	0,5	0,7	1,1	1,7	2,3	2,9

a	-17	-15	-12	-9	-6	-3	0	3	6	9
ø125	0,7	1,1	1,5	2,0	2,5	2,9	3,4	3,9	4,3	4,8

a	-15	-13	-10	-5	0	5	10
ø150	2,1	2,4	2,9	3,9	4,8	5,6	6,7
9.1.2006 →	1,8	2,1	2,7	3,6	4,5	5,4	6,3

a	-20	-18	-15	-10	-5	0	5	10	12
ø160	1,4	1,7	2,3	3,3	4,3	5,3	6,3	-	-
9.1.2006 →	0,7	1,1	1,6	2,6	3,6	4,5	5,4	6,3	6,7

a	-25	-20	-15	-10	-5	0	10	20
ø200	1,4	2,5	3,7	4,9	6,1	7,3	9,8	12,5
13.2.2006 →	1,5	2,8	4,0	5,2	6,5	7,7	10,2	12,7

KK-80-C

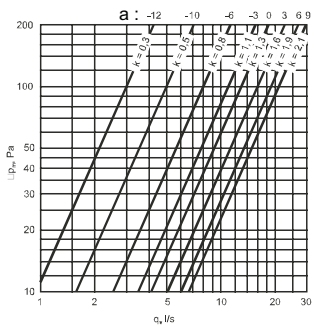

KK-100-C

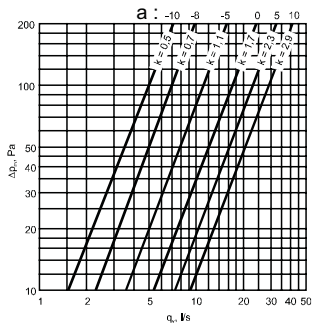

KK-125-C

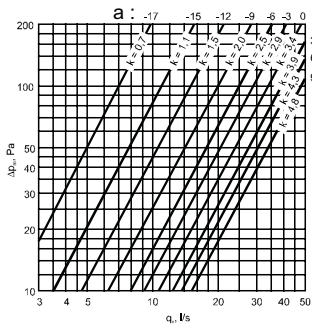

KK-150-C

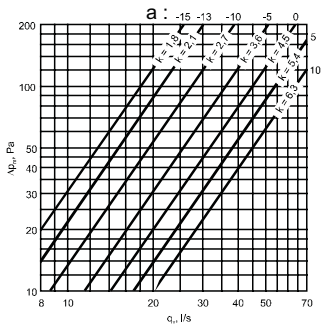

KK-160-C

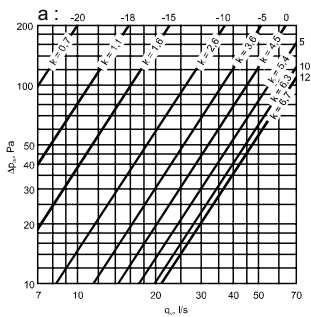

KK-200-C

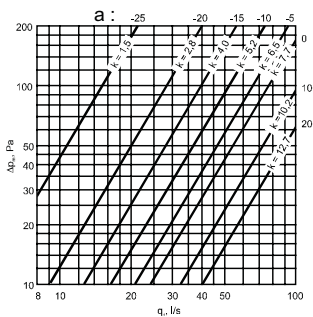

KSO, KSOF, KSOV

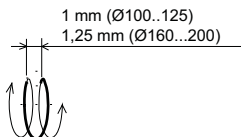
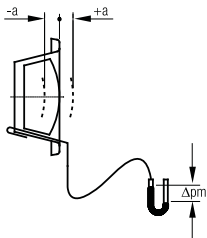

Ø100 a	k
-15	0,5
-12	0,8
-10	1,0
-5	1,4
0	1,9
5	2,3
10	2,8

Ø125 a	k
-10	1,5
-5	2,1
0	2,7
5	3,3
10	4,0

Ø160 a	k
-10	2,0
-5	2,8
0	3,6
5	4,4
10	5,3
15	6,2

Ø200 a	k
-3	1,8
0	2,4
5	3,8
10	5,0
15	6,3
20	7,5
25	8,6

KSO/KSOF/KSOV-100-C

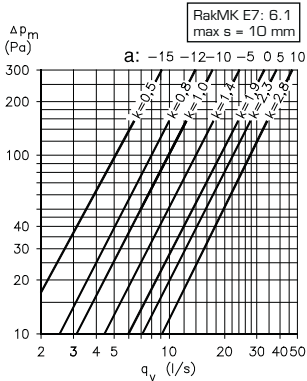

KSO/KSOF/KSOV-125-C

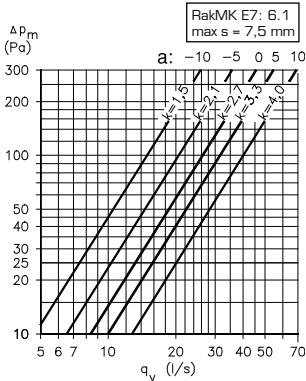

KSO/KSOF/KSOV-160-C

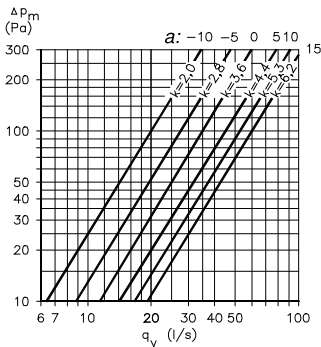

KSO/KSOF/KSOV-200-C

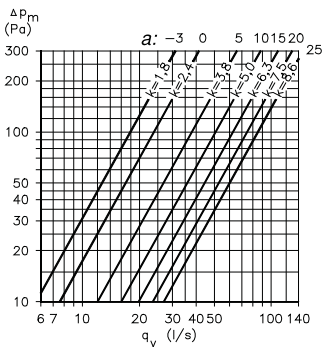

KSOM

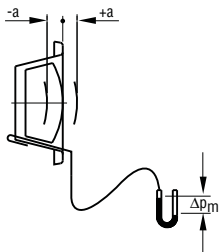

Ø100 a	k
-15	0,5
-12	0,8
-10	1,0
-5	1,4
0	1,9
5	2,3
10	2,8

Ø125 a	k
-15	0,6
-12	1,1
-10	1,5
-5	2,1
0	2,7
5	3,3
10	4,0

Ø100

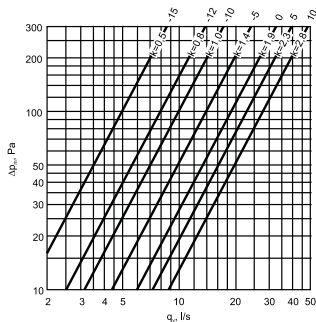

Ø125

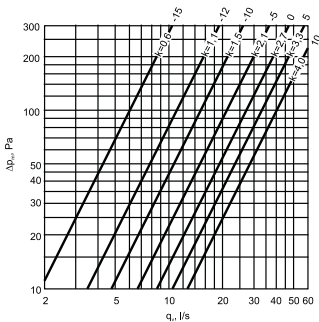

KSOS

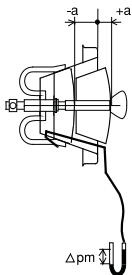

KSOS-100	
a	k
-15	0,5
-12	0,8
-10	1,0
-5	1,4
0	1,9
5	2,3
10	2,8

KSOS-125	
a	k
-10	1,5
-5	2,1
0	2,7
5	3,3
10	4,0

KSOS-100-C

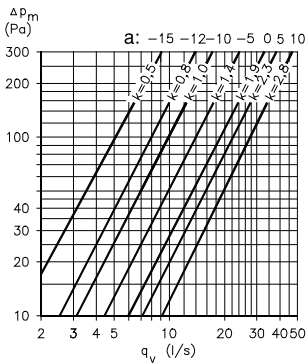

KSOS-125-C

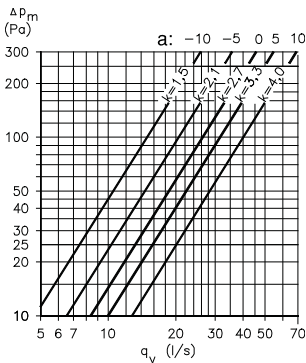

KGEA / KGEB-1

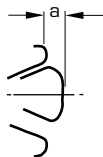

a	-20	-18	-15	-10	-5	0	+4
k	0,58	0,77	1,0	1,4	2,0	2,5	2,8

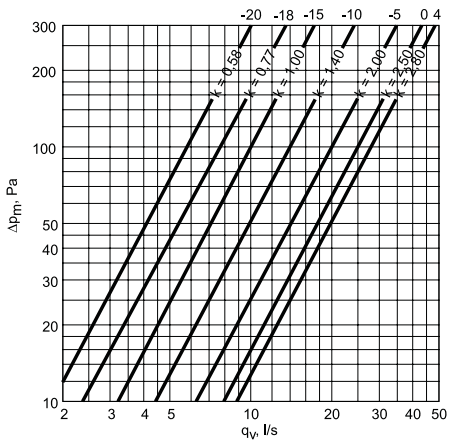

KGEB

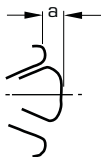

ø100	a	-11	-9	-6	0	+6	+9
	k	0,39	0,56	0,82	1,36	1,9	2,2
ø125	a	-22	-18	-12	-6	0	+6
	k	0,88	1,3	1,8	2,4	2,9	3,4
ø160	a	-24	-18	-12	-6	0	+6
	k	1,8	2,5	3,1	4,1	4,4	5,0
	k *)	1,8	2,5	3,1	3,9	4,6	5,4

*) 1.1.2003 alkaen

KGEB-100-C

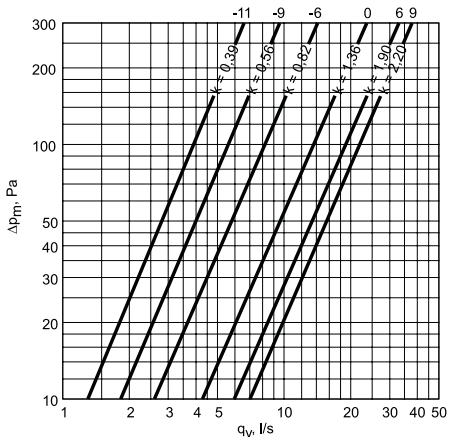

KGEB-125-C

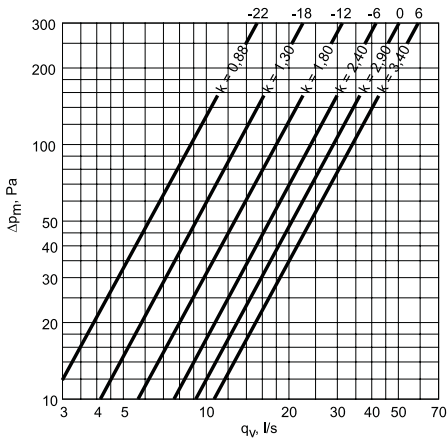

KGEB-160-C

1.1.2003 →

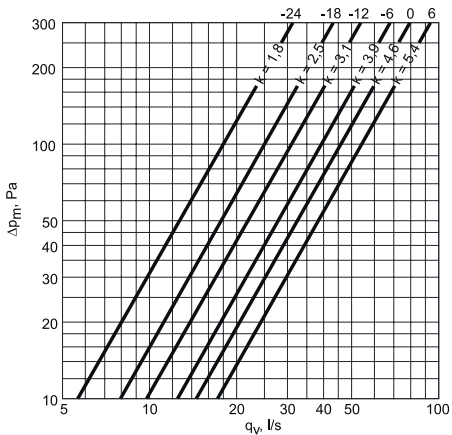

KGFC

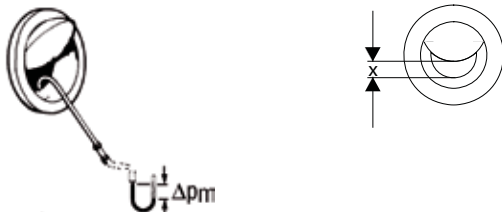

x (mm)	5	10	15	20	25	30	40	50
k	0,25	0,49	0,78	1,1	1,3	1,6	2,3	2,9

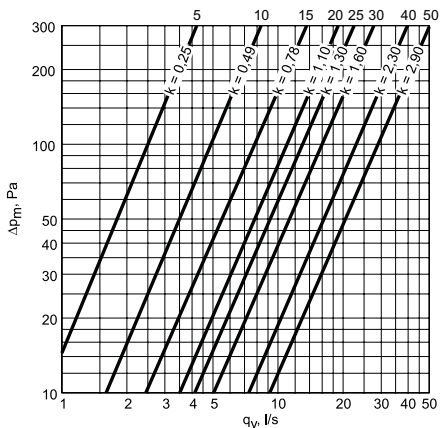

BYBA

a	1	2	3	4	5	6
k	0,24	0,42	0,59	0,80	0,98	1,2

a	7	8	9	10	11	12
k	1,5	1,6	1,8	2,1	2,3	2,5

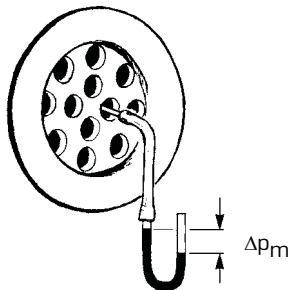

BYFA

k-kerroin	BYFA-3	BYFA-4		
		Pos, 1 ¹⁾	2 ²⁾	3 ³⁾
Perusilmav.	1,10	0,70	0,80	0,90
Tehostettu iv	4,70	3,00	3,00	3,00

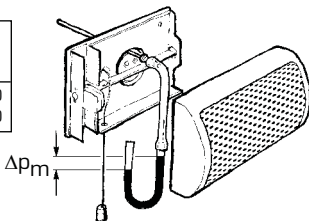

1) Tila 1 = säätöpellissä 2 tulppaa (toimitetaan näin)

2) Tila 2 = 1 tulppa poistettu

3) Tila 3 = 2 tulppaa poistettu

KIV

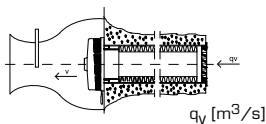

$$v = q_v / 0,015$$

$$q_v = v * 0,015$$

KIV-100

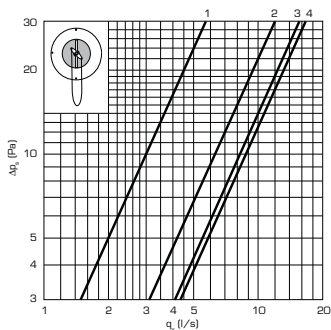

KIV-125

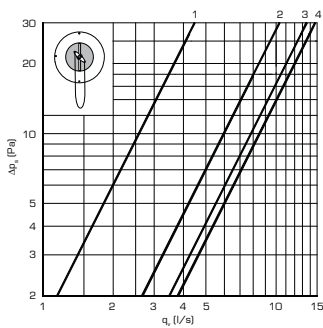

KIV-125

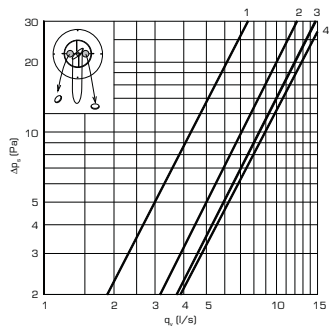

TG/TGE, AVS, SV, USR

TG

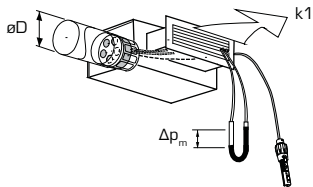

TGE

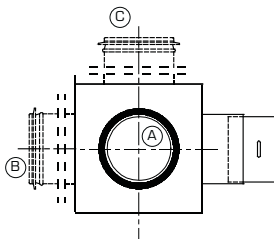
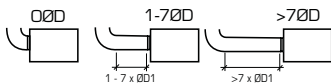
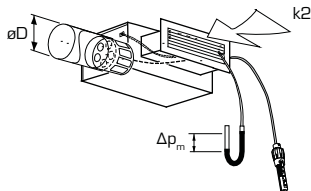

10/2011 lähtien

B x H	ØD	k1 TG			k2 (AVS) TGE			k2 (SV2, USR) TGE		
		ØD	1-7D	>7D	A	B	C	A	B	C
200x100	125	10,1	10,6	10,1	9	11	10	11	13	11
300x100	160	17,1	19,9	17,3	15	17	16	19	21	19
400x100	160	17,1	19,9	17,3	22	22	22	25	31	26
500x100	200	27,0	30,8	27,9	34	28	25	34	37	36
600x100	250	47,1	48,8	39,9	36	32	36	38	35	39
800x100	250	47,1	48,8	39,9	53	47	46	60	50	51
1000x100	315	47,1	48,8	39,9	63	59	60	62	62	63
300x150	200	27,0	30,8	27,9	25	27	20	25	34	24
400x150	250	47,1	48,8	39,9	32	34	36	45	46	39
500x150	250	47,1	48,8	39,9	43	47	42	50	52	48
600x150	250	47,1	48,8	39,9	53	53	53	65	92	62
800x150	315	65,9	67,2	64,1	74	77	73	86	90	82
1000x150	315	65,9	67,2	64,1	109	91	96	118	106	103
400x200	250	47,1	48,8	39,9	45	52	43	47	63	45
500x200	315	65,9	67,2	64,1	60	63	63	74	74	61
600x200	315	65,9	67,2	64,1	75	77	71	80	89	70
800x200	315	65,9	67,2	64,1	82	107	104	105	131	107
1000x200	315	65,9	67,2	64,1	176	124	139	177	154	151

Activent

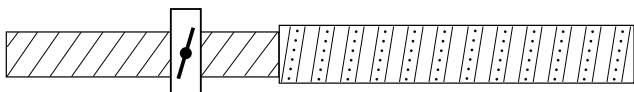

Ilmavirta säädetään pellillä

Koko	Suutinsektori				
	2x60°	180° 2x90	240° 2x120	300°	360°
Ø200	2,83	4,24	5,66	7,0	8,49
Ø250	3,38	5,0	6,76	8,27	10,14
Ø315	4,47	6,71	8,94	11,31	13,42
Ø400	5,66	8,45	11,31	14,0	16,90
Ø500	6,76	10,14	13,52	16,90	20,28

k-arvo antaa ilmavirran 1m kohden.

UNO

Suutinkampaa/m	3	4	8	16
k-varvo	1.3	1.9	3.6	7.2

k-arvo antaa ilmavirran 1m kohden.

IQFF STELLA

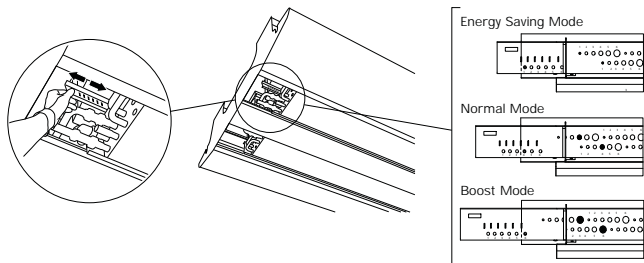
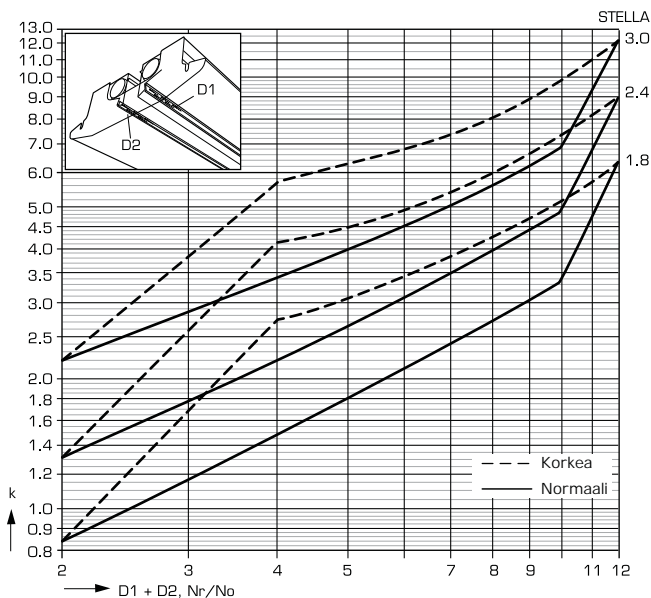

IQIF WEGA

IQIF-aaa-11-cc-d-e, IQIF-aaa-13-cc-d-e, IQIF-135-22-cc-d-e (Ø125)
 IQIF-300-51-cc-d-e, IQIF-300-53-cc-d-e (Ø160)

Nro	k120	k135	k180	k240	k300
1	0,36	0,00	0,56	0,87	1,01
2	0,72	0,35	1,13	1,63	1,97
3	1,16	0,81	1,79	2,54	3,16
4	1,65	1,60	2,53	3,62	4,63
5	2,03	2,85	3,16	4,53	5,76
6	3,03	3,60	4,81	6,92	9,02

IQIF-aaa-71-cc-d-e, IQIF-aaa-73-cc-d-e (Ø100)

Nro	k120	k180	k240
1	0,36	0,56	0,87
2	0,72	1,13	1,63
3	1,16	1,79	2,54
4	1,65	2,53	3,38
5	2,03	3,08	4,08
6	2,89	4,32	5,55

D1 = D2

$q = k \sqrt{\Delta p_m}$ [l/s] [Pa]	$q = 3,6 k \sqrt{\Delta p_m}$ [m ³ /h] [Pa]
---	---

D1 ≠ D2

$q = \left[\frac{k_{D1}}{2} + \frac{k_{D2}}{2} \right] \sqrt{\Delta p_m}$ [l/s] [Pa]	$q = 3,6 \left[\frac{k_{D1}}{2} + \frac{k_{D2}}{2} \right] \sqrt{\Delta p_m}$ [m ³ /h] [Pa]
--	--

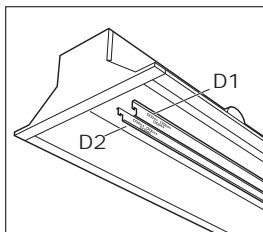

IQFD/IQFE

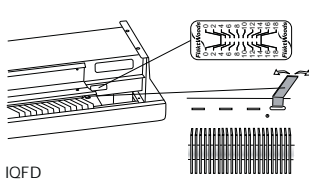
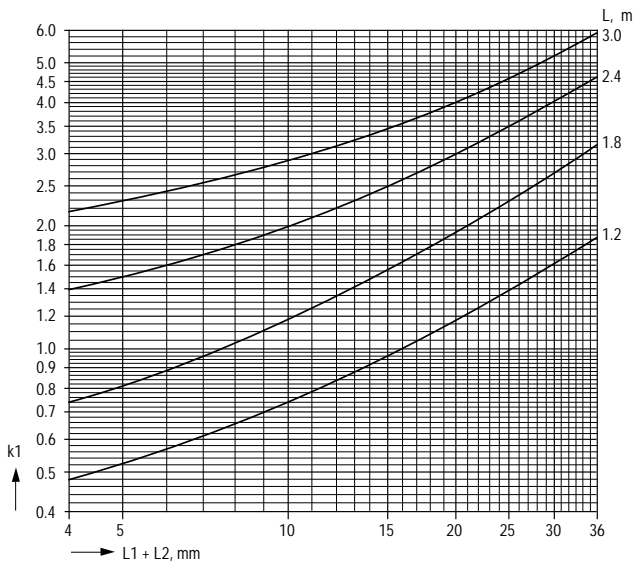
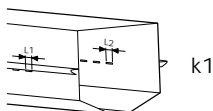

IQFD

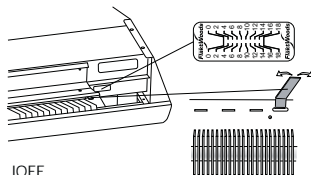

IQFE

IQFD/IQFE

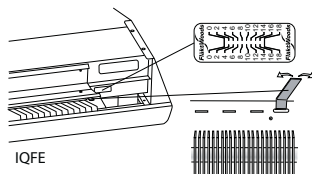
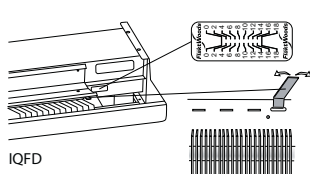
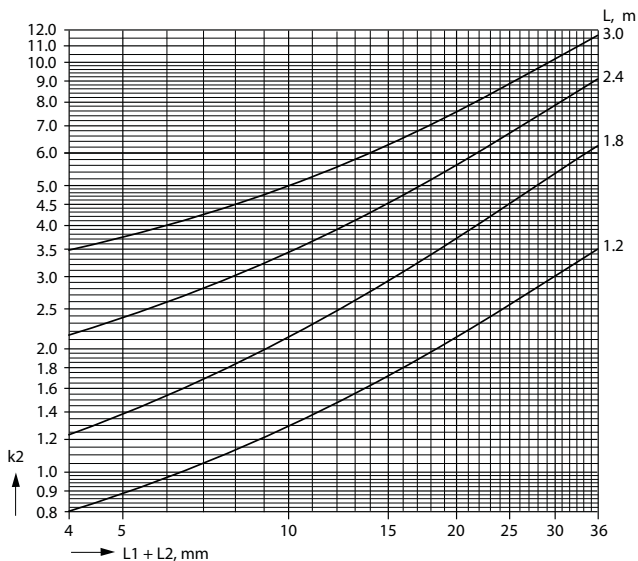
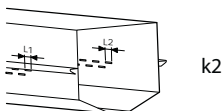

IQFC

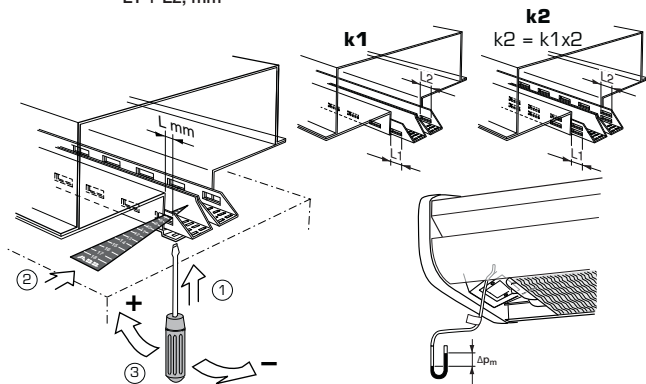
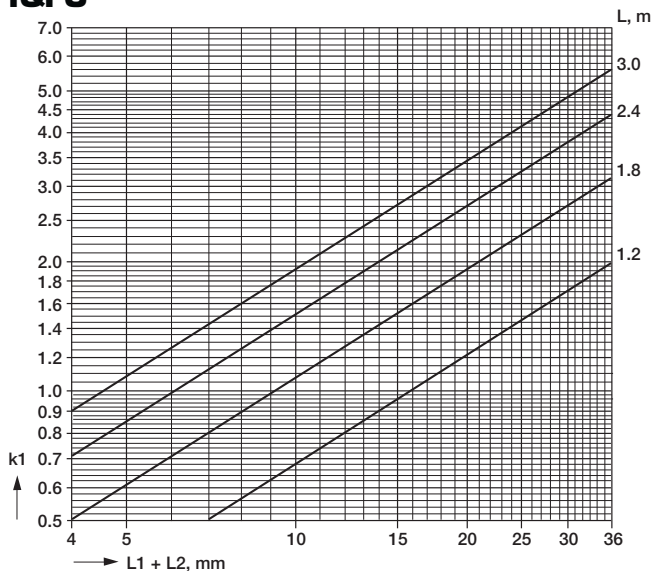

IQSA

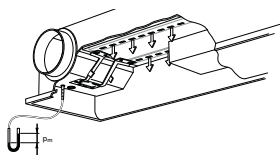
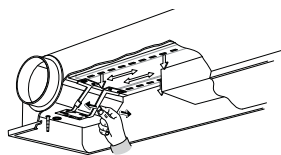
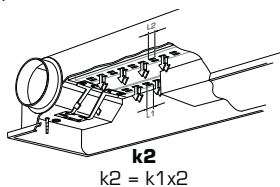
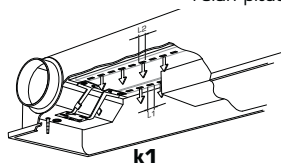
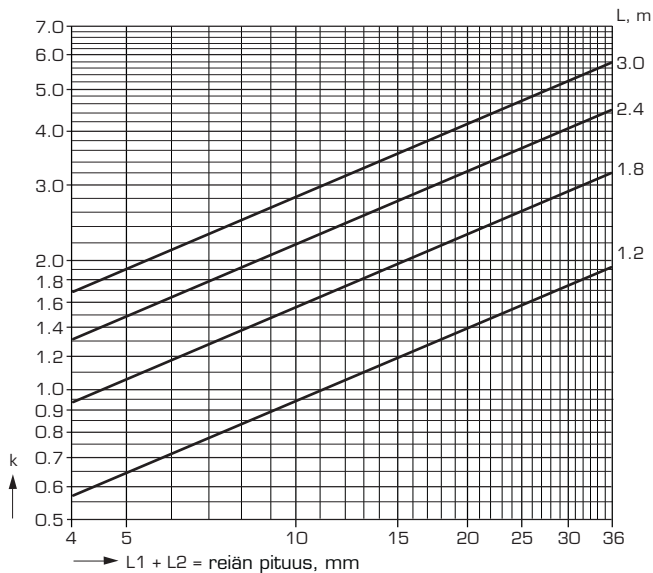

IQTA

L, m

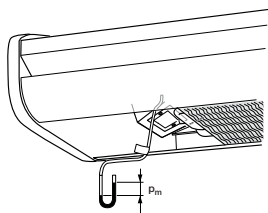
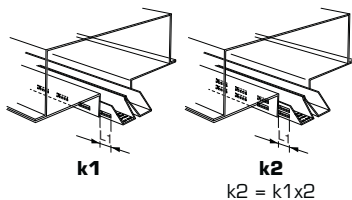
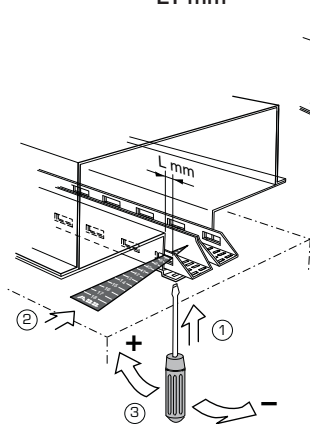
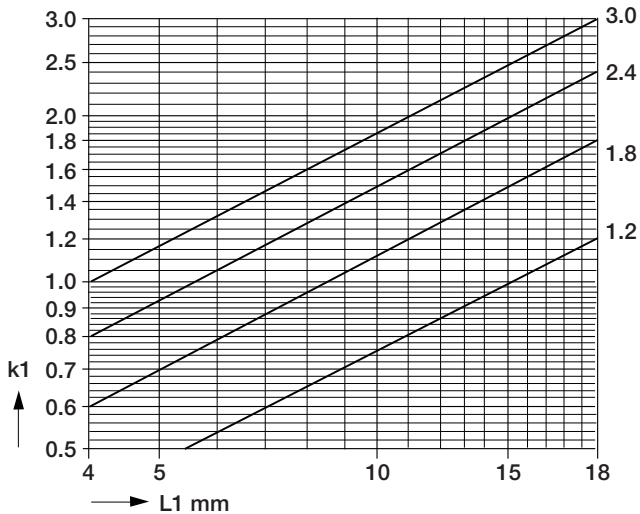

QP(S,B,D,)A

Vesivirta

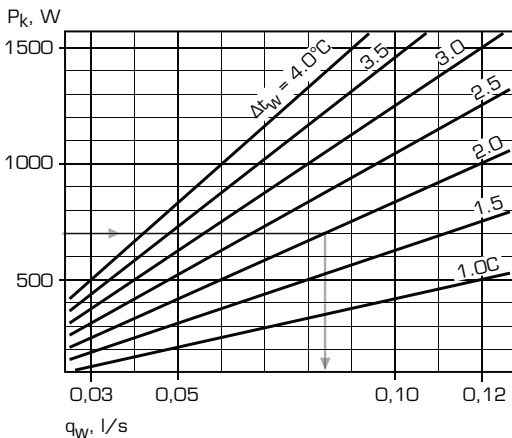

Painehäviö, vesi, kPa

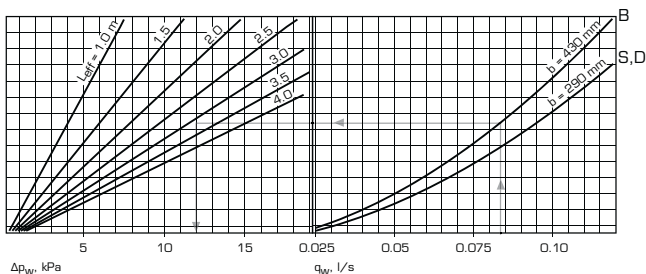

IQCA

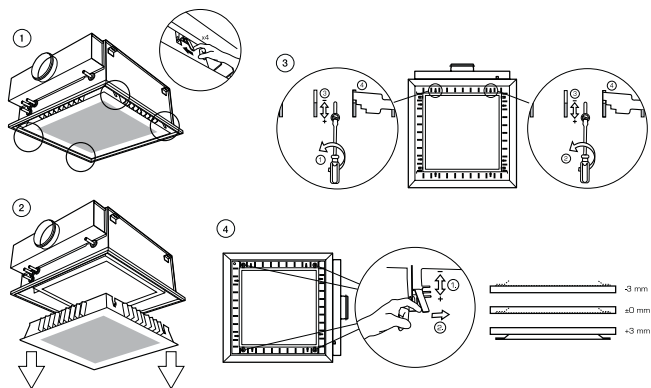
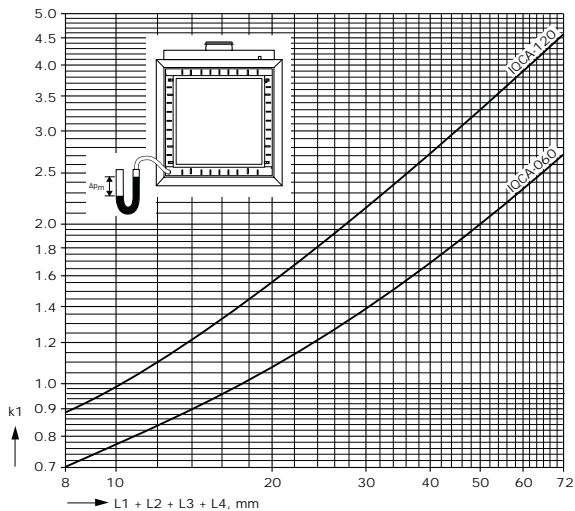

EMA(S,E), EMS(S,D)

EMA(S,E)-1 ja EMS(S,D)-1 05/2014 lähtien

EMA(S,E)-5 ja EMS(S,D)-5/-6 08/2014 lähtien

Koko	100	125	160	200	250	315	400	500	630
Ilmavirtasäädin									
EMAS, EMAE *	4,2	6,0	10	16	25	40	64	-	-
EMSS, EMSD *	4,2	6,0	10	16	25	40	64	90	165

*) K-arvo on keskiarvo koko käyttöalueelle (säätöläpän avaus 30-100%).

EMSF

20.06.2008 alkaen

Koko	100	125	160	200	250	315	400	500	630
Mittalaite									
EMSF	4,0	6,0	10	16	25	40	64	98	152

EHA(S,E), EHS(S,D), EHSF

Koko	100	125	160	200	250	315	400	500	630
Ilmavirtasäädin									
EHAS, EHAE	5,6	11	20	32	52	77	121	-	-
EHSS, EHSD	5,6	11	20	32	52	77	121	184	275
Mittalaite									
EHSF	5,6	11	20	32	52	77	121	184	275

HVSA

Koko	100	125	160	200
Huoneistosäädinyksikkö				
HVSA	4,0	6,0	10	16

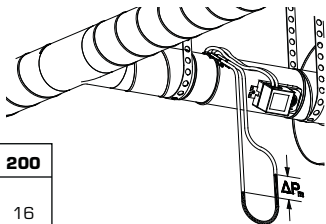

EMA(S,E), EMS(S,D) arvojen asettelu

1

Ilmavirtayksikön valinta

Tehdasasetus
l/s

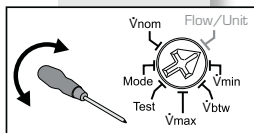

+

Edit $\Delta 10^\circ$

-

	l/s	= l/s
	Diag	
	m ³ /h	

Valinnan jälkeen näyttö vilkkuu kaksi kertaa vahvistaen uuden asetuksen tallentamisen.

2

Vmax asettelu

Tehdasasetus
100% Vnom

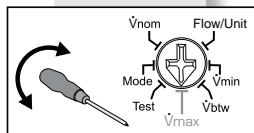

+

Edit $\Delta 10^\circ$

-

Esimerkki:
Vmax = 100 l/s

	l/s	
	Diag	
	m ³ /h	

Valinnan jälkeen näyttö vilkkuu kaksi kertaa vahvistaen uuden asetuksen tallentamisen.

Asetukset tehtyäsi käännä toiminnonvalitsin osoittamaan toimintoa "Flow" saadaksesi ilmavirtanäytön aktiiviseksi.

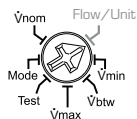

3

Vmin asettelu

Tehdasasetus
0% Vnom

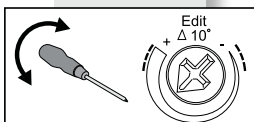
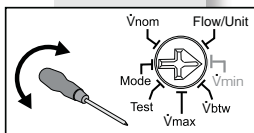

Esimerkki:

Vmin = 50 l/s



Valinnan jälkeen näyttö vilkkuu kaksi kertaa vahvistaen uuden asetuksen tallentamisen.

4

Ohjausviesti- alueen asettelu

Tehdasasetus
0-10 V

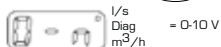
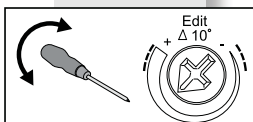
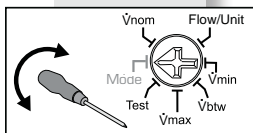

Valinnan jälkeen näyttö vilkkuu kaksi kertaa vahvistaen uuden asetuksen tallentamisen.

Asetukset tehtyäsi käännä toiminnonvalitsin osoittamaan toimintoa "Flow" saadaksesi ilmavirtanäytön aktiiviseksi.

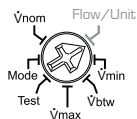

EMPA, EMPD arvojen asettelu

1

Paineyksikön valinta

Tehdasasetus

Pa

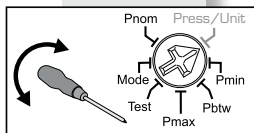

Edit $\Delta 10^+$

Pa
Diag
inH₂Ox10⁻³ = Pa

Pa
Diag
inH₂Ox10⁻³ = inH₂Ox10⁻³

Valinnan jälkeen näyttö vilkkuu kaksi kertaa vahvistaen uuden asetuksen tallentamisen.

2

Pmax asettelu

Tehdasasetus

300 Pa

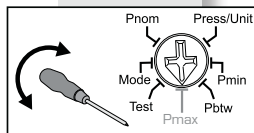

Edit $\Delta 10^+$

Esimerkki:
Pmax = 100 Pa

Asetukset tehtyäsi käännä toiminnonvalitsin osoittamaan toimintoa Press/Unit saadaksesi painenäytön aktiiviseksi.

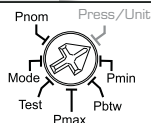

3

Pmin asettelu

Tehdasasetus
0 Pa

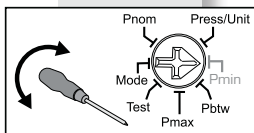

Esimerkki:
Pmin = 50 Pa

Valinnan jälkeen näyttö vilkkuu kaksi kertaa vahvistaen uuden asetuksen tallentamisen.

4

Ohjausviesti- alueen asettelu

Tehdasasetus
0-10 V

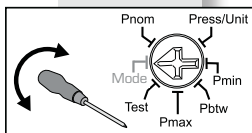

Pa
Diag inH₂Ox10⁻³ = 0-10 V

Pa
Diag inH₂Ox10⁻³ = 2-10 V

Valinnan jälkeen näyttö vilkkuu kaksi kertaa vahvistaen uuden asetuksen tallentamisen.

Asetukset tehtyäsi käännä toiminnonvalitsin osoittamaan toimintoa Press/Unit saadaksesi painenäytön aktiiviseksi.

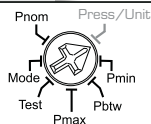

IRIS

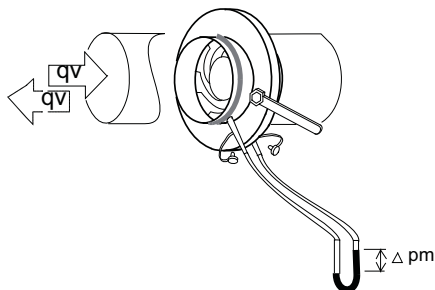

Ø	a							
	1	2	3	4	5	6	7	8
80	6,1	4,1	3,2	2,3	1,4	0,9	0,6	-
100	10,4	7,5	6,0	4,5	3,4	2,5	1,7	0,9
125	13,8	8,8	6,5	4,7	3,5	2,7	1,5	-
150	24,1	16,5	13,4	11,0	8,9	6,9	5,2	3,7
160	22,1	14,8	12,5	10,7	8,5	6,8	4,9	3,5
200	44,2	30,9	23,2	18,2	14,0	11,0	8,4	5,0
250	64,4	45,6	38,7	30,7	24,1	18,4	12,8	8,9
315	118,0	70,0	58,7	45,1	37,0	30,0	21,8	15,8
400	131,0	102,0	88,3	67,3	52,7	38,5	28,4	15,5
500	230,0	177,0	146,0	112,0	88,5	66,6	48,0	30,0
630	451,0	297,0	238,0	169,0	127,0	91,6	62,8	35,1
800	489,0	402,0	344,0	267,0	217,0	170,0	122,0	73,7

Ø	a						
	1,5	2,5	3,5	4,5	5,5	6,5	7,5
100	7,9	6,6	5,2	3,8	2,9	2,1	1,2
125	10,4	7,3	5,5	4,0	3,1	2,2	-
150	20,0	14,9	12,0	10,0	7,9	6,0	4,4
160	17,2	13,4	11,5	9,5	7,5	5,6	4,0
200	36,6	26,9	20,6	15,9	12,3	9,6	6,5
250	53,5	41,8	34,5	27,3	21,4	15,8	10,9
315	88,3	64,5	53,0	42,4	33,3	25,9	19,0

IRIS-080

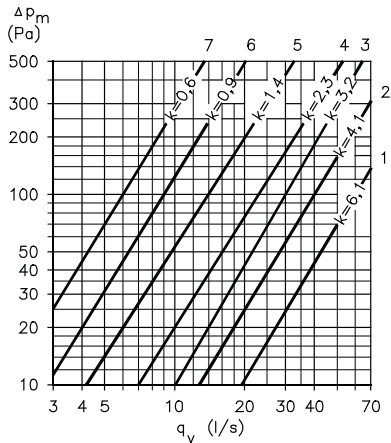

IRIS-100

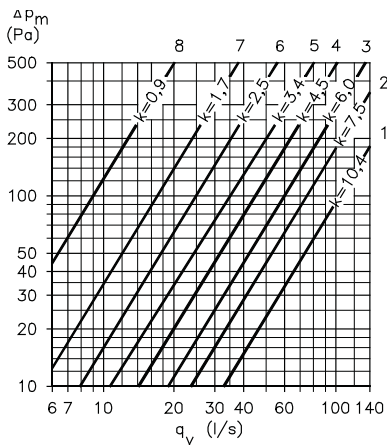

IRIS-125

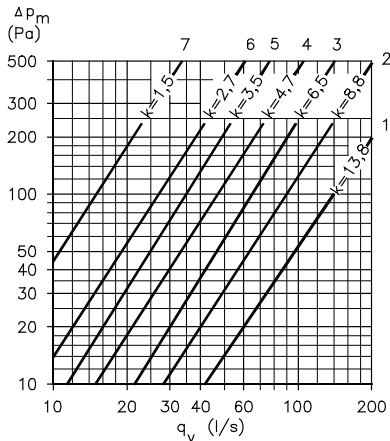

IRIS-150

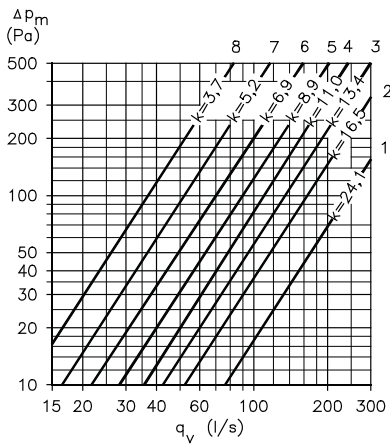

IRIS-160

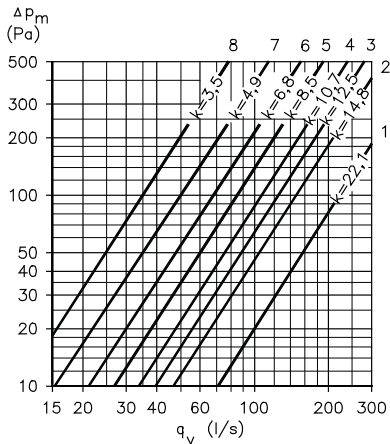

IRIS-200

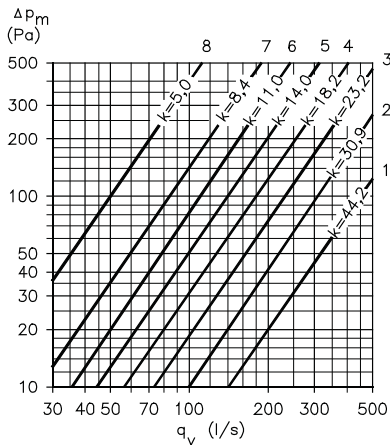

IRIS-250

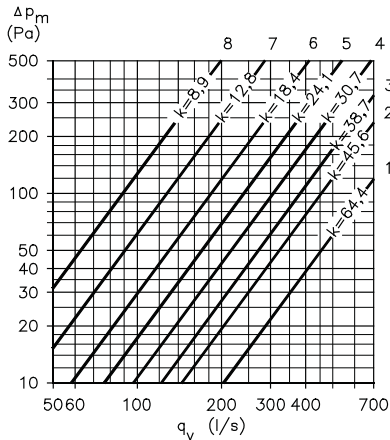

IRIS-315

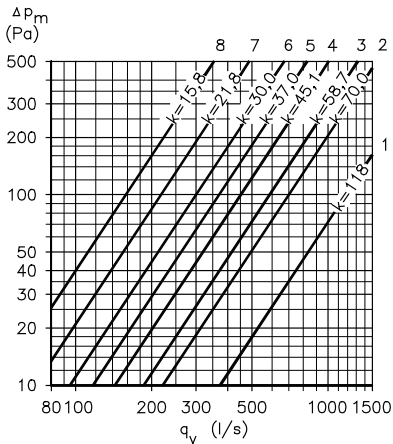

IRIS-400

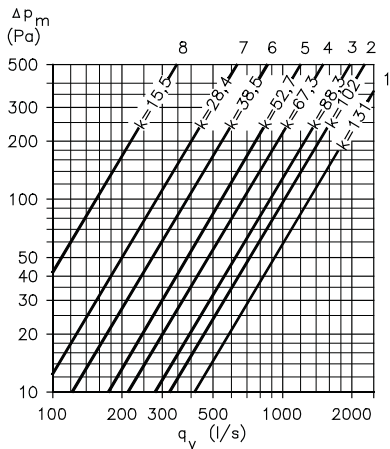

IRIS-500

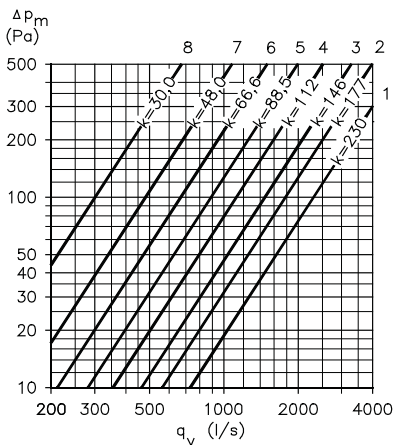

IRIS-630

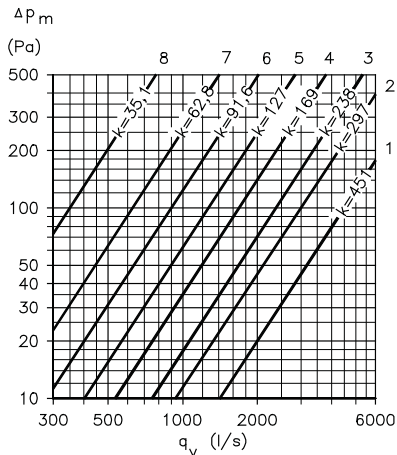

IRIS-800

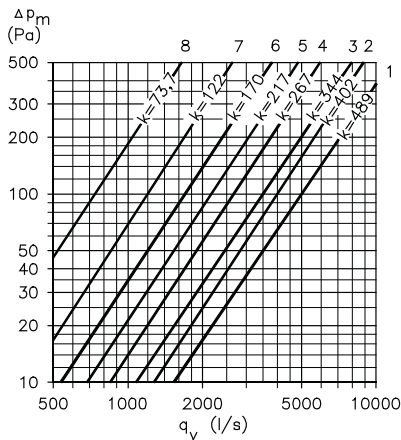

MR

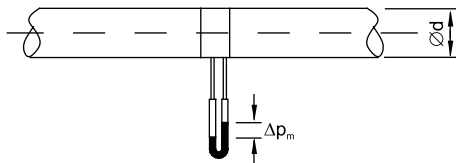

MR	k
100	4,0
125	7,4
160	13,6
200	23,4
250	40
315	66
400	114
500	180
630	294
800	481
1000	764
1250	1330

Vanhat tuotteet

CTAA

(toimitettu ennen 09.1996)

Number of slots	k1
1, 2	16.8
3, 4	26.9

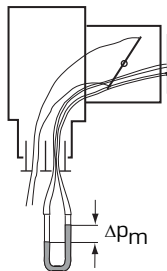

CTBA (mittaus kanavassa)

(toimitettu ennen 09.1996)

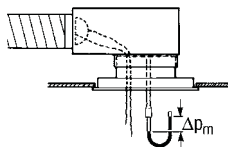

Koko	b = 1	b = 2, 5	b = 3	b = 4	b = 4
16-b	3,70	6,30	8,20	8,20	7,50
20-b	6,00	11,2	12,9	14,3	11,1
25-b	9,30	14,1	14,4	15,2	14,4
31-b	12,7	19,9	22,4	24,3	21,7
40-b	16,2	28,3	32,9	32,9	30,2
50-b	20,9	38,3	46,9	50,3	39,7

CTCA (mittaus kanavassa)

(toimitettu ennen 09.1996)

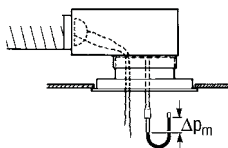

Koko	b = 1	b = 2, 5	b = 3	b = 4	b = 4
16-b	2,70	5,10	6,00	6,80	6,00
20-b	6,00	10,6	12,7	11,6	9,80
25-b	9,00	12,5	14,1	14,2	14,1
31-b	14,3	22,4	25,0	27,0	23,9
40-b	18,6	28,3	32,4	36,5	35,9
50-b	20,6	37,5	51,6	60,3	47,4

CTBA/CTCA DTTZ/CTTZ-laatikolla

(toimitettu 09.1996 alkaen)

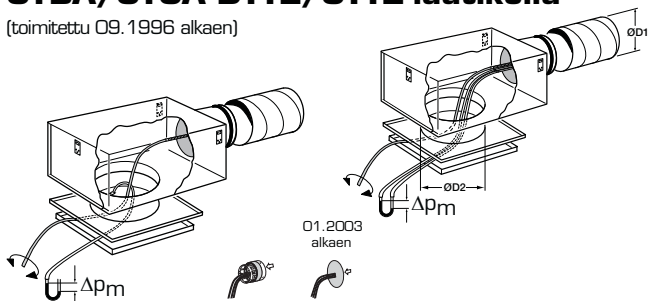

ØD1	k1	k1	ØD2	k2
100	7.40	7.40	160	13.7
125	13.0	13.0	200	20.0
160	25.3	21.5	250	28.5
200	38.0	36.0	315	35.4
250	63.5	63.5	400	43.0
315	97.0	97.0	500	80.0

Muut ilmalaitteet, säätö tasauslaatikossa CTTZ

(toimitettu 09.1996 alkaen)

Pätee seuraaviin tuotteisiin

CTEL	DRAD	DRAR	CTUR
CTFA	DRAE	DRAK	UKH
CTFB	DRBA	DRBR	jne.
CTTZ	DRBE	DRBK	

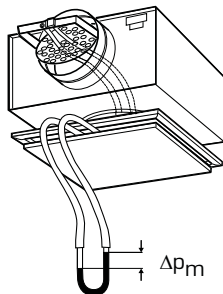

Koko	Liitäntä mitta ØD1	k-arvo	
		Tulo	Meno
10	100	6,60	5,60
12	125	10,3	8,80
16	160	16,8	14,3
20	200	26,9	22,9
25	250	41,8	35,5
31	315	64,5	54,8

CTF(A,B,J)

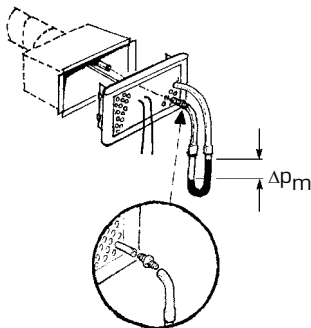
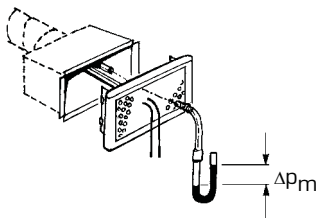

Vanha versio jossa yksi
mittapistee

Koko	k1
08	4,50
10	7,90
12	10,6
16	12,2

Kaksi mittapistettä
(toimitettu ennen 08.1996)

Koko	k1
08	3,80
10	6,60
12	10,3
16	16,8
20	26,8

CTKA

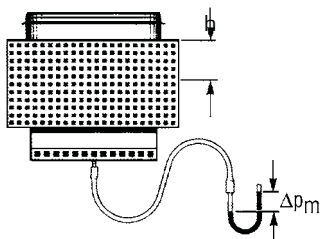

Koko	h	Flow configurations			
		1-v	2-v	3-v	4-v
031	0	30,8	53,4	65,0	84,8
	50	25,6	45,5	58,9	77,1
	100	18,4	35,0	50,0	64,5
	125	14,1	27,6	39,4	51,6
	150	11,2	21,4	31,0	39,7
050	0	72,1	134	159	203
	100	49,6	95,4	134	177
	175	32,8	68,0	94,0	129
	200	28,8	58,6	80,0	111
	225	23,8	48,6	64,8	84,4
080	0	159	305	363	527
	150	120	231	309	453
	200	100	194	260	387
	250	83,0	165	232	335
	300	69,0	134	194	275
350	51,0	100	144	206	

CTPB + ATTA

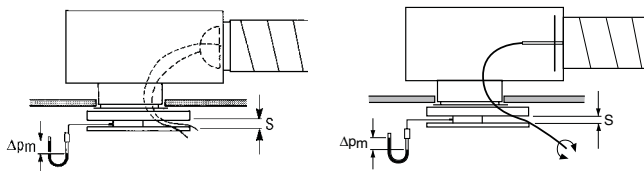

Koko		Mittaus laitteessa				Mittaus ATTA-laatikossa
125	avaus k-kerroin	20 5,70	25 6,30	30 6,90	35 7,60	ØD1 = 100 mm k1 = 7,40
160	avaus k-kerroin	25 8,80	30 9,30	35 10,5	40 11,4	ØD1 = 125 mm k1 = 13,0

CTPB + ATTB

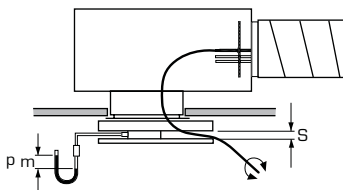

ØD1	0ØD1	1-7ØD1	>7ØD1
125	10,6	11,7	10,7
160	17,6	20,0	18,5

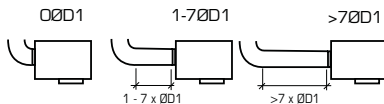

CYLD

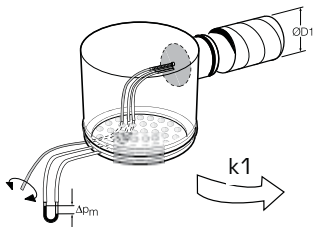

ATTA
03.2001 lähtien 03.2003 lähtien



Koko	ØD	k1	k1
100	100	7,4	7,4
125	125	13,0	13,0
160	160	21,5	15,9
200	200	36,0	24,5
250	250	63,5	37,7
315	315	97,0	64,8

CYLP, CYLO

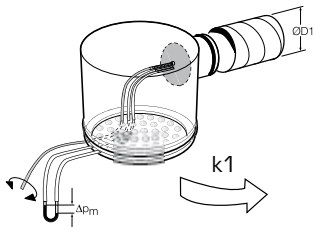

DTTZ
09.1996 lähtien



ATTA
03.2001 lähtien 03.2003 lähtien



ØD1	k1	k1	k1
100	7,4	7,4	7,4
125	13,0	13,0	13,0
160	25,3	21,5	15,9
200	38,0	36,0	24,5
250	63,5	63,5	37,7
315	97,0	97,0	64,8

DAAD, DAAP

DAAP

Koko	k1
06	4,00
09	4,00
12	7,40
15	7,40

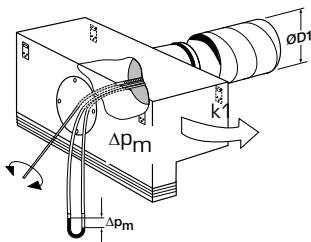

03.2001
lähtien

DAAD

Koko	Rakojen lkm	k1	k1
06, 09	1	7,40	7,40
12, 15	1	13,0	13,0
06, 09	2	13,0	13,0
12, 15	2	25,3	21,5
Kaikki	3	25,3	21,5



DCKA

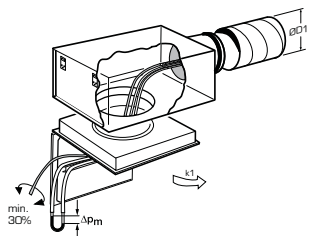

ØD1	0ØD1	1-7ØD1	>7ØD1
100	6,7	7,0	6,3
125	10,6	11,7	10,7
160	17,6	20,0	18,5
200	26,9	31,6	29,2
250	44,8	50,5	46,7
250 *	40,9	43,2	38,8
315	75,0	80,0	80,0
315 *	64,4	63,2	66,4

* 08.03.2010 lähtien

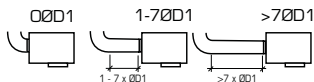

DS(K,R)S, DS(K,R)F

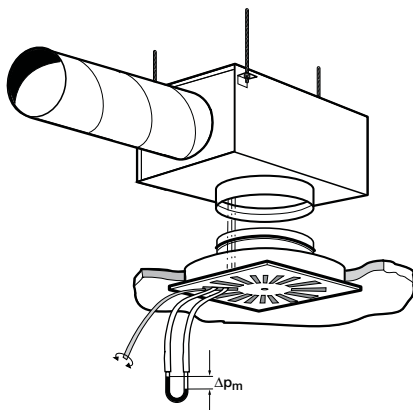

ØD	k1
160	15.9
200	24.5
250	37.7

DV(K,R)F, DV(K,R)S

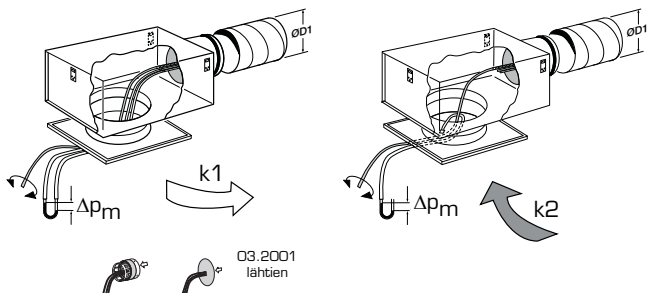

ØD1	k1	k1	k2
160	25,3	21,5	16,0
200	38,0	36,0	27,0
250	63,5	63,5	40,4

DYCB, DYKB + ATTB

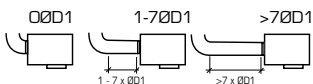
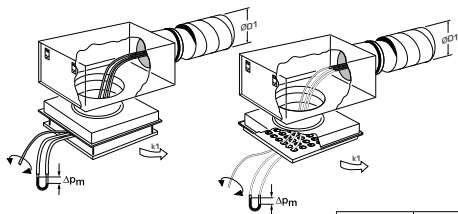

ØD1	Ø0D1	1-7ØD1	>7ØD1
100	6,7	7,0	6,3
125	10,6	11,7	10,7
160	17,6	20,0	18,5
200	26,9	31,6	29,2
250	44,8	50,5	46,7
315	75,0	80,0	80,0

DYCC, DYKC (DYCH, DYKH + ATTB)

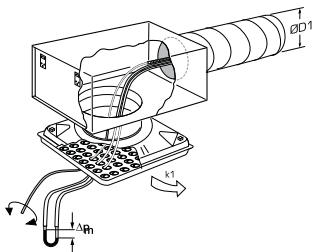

ØD1	Ø0D1	1-7ØD1	>7ØD1
100	6,7	7,0	6,3
125	10,6	11,7	10,7
160	17,6	20,0	18,5
200	26,9	31,6	29,2
250	40,9	43,2	38,8
315	64,4	63,2	66,4

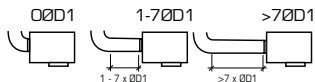

DYFA

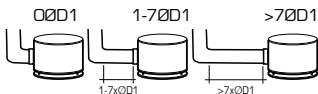
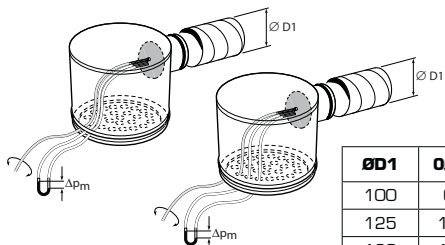

ØD1	0ØD1	1-7ØD1	>7ØD1
100	6,7	7,0	6,3
125	10,6	11,7	10,7
160	17,6	20,0	18,5
200	26,9	31,6	29,2
250	44,8	50,5	46,7
250 *	40,9	43,2	38,8
315	75,0	80,0	80,0
315 *	64,4	63,2	66,4

* 08.03.2010 lähtien

DYKA, DYCA

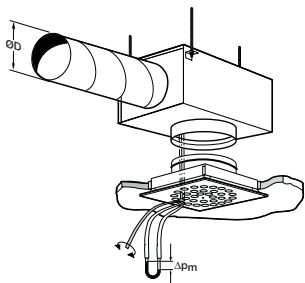

ØD	k1
100	7.4
125	13.0
160	15.9
200	24.5
250	37.7
315	64.8

DYK(C,K)

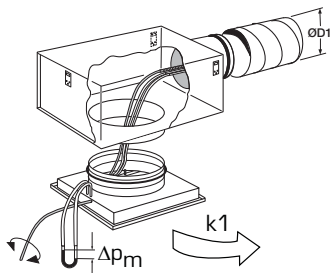

ØD1	k1	k1
125	13.0	13.0
160	25.3	21.5
200	38.0	36.0
250	63.5	63.5
315	97.0	97.0

DYSA

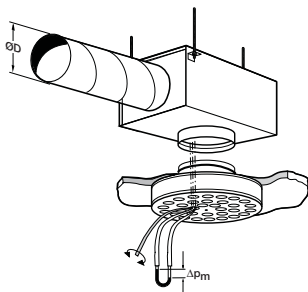

ØD	k1
100	7.4
125	13.0
160	15.9
200	24.5
250	37.7
315	64.8

DYSB + ATTB

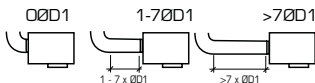
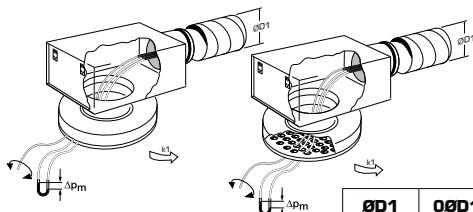

ØD1	0ØD1	1-7ØD1	>7ØD1
100	6,7	7,0	6,3
125	10,6	11,7	10,7
160	17,6	20,0	18,5
200	26,9	31,6	29,2
250	44,8	50,5	46,7
250 *	40,9	43,2	38,8
315	75,0	80,0	80,0
315 *	64,4	63,2	66,4

* 08.03.2010 lähtien

DYVA

(toimitettu 05.1998 alkaen)

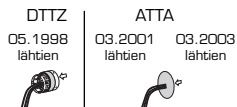
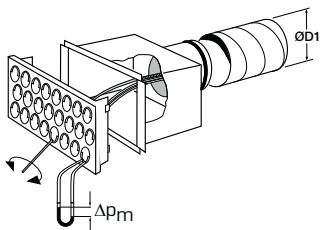

ØD1	k1	k1	k1
100	7.4	7.4	7.4
125	13.0	13.0	13.0
160	25.3	21.5	15.9
200	38.0	36.0	24.5

Floormaster FM-90

mittauspellillä

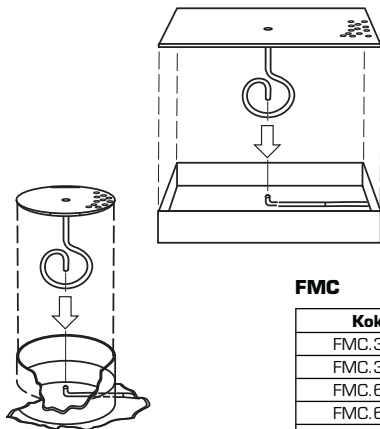

FMC

Koko	k-kerroin
FMC.303	3.16
FMC.306	3.16
FMC.603	8.27
FMC.606	8.27
FMC.608	11.0

FMK, FMH, FMR

Liitäntämitta mm	k-kerroin
80	2.31
100	3.60
125	5.63
160	9.24
200	14.4
250	22.6
315	35.8
400	57.7
500	90.3
630	143
800	231
1000	360

FMP

Koko	Korkeus		
	600	1200	2000
FMP.03	6.88		
FMP.04	9.19		
FMP.05	13.8	27.5	
FMP.06	18.4	41.3	
FMP.07	23.0	48.3	
FMP.08	32.1	64.2	110
FMP.09	41.3	82.7	138
FMP.10	48.3	101	179
FMP.11	68.8	129	220

Tuloilmalaite GPD.010

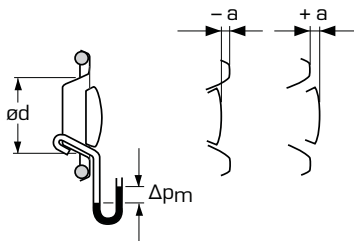

"a" mm	-15	-10	-5	0	5	10
k-kerroin	0.60	0.78	0.90	1.08	1.20	1.32

HPKA + ATTB

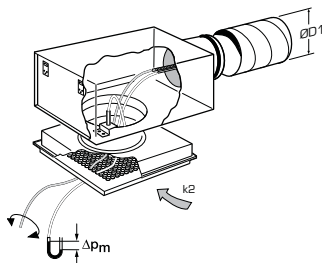

$\varnothing D$	k_2
100	14,6
125	18,6
160	27,8
200	38,5
250	48,9

HPSA + ATTB

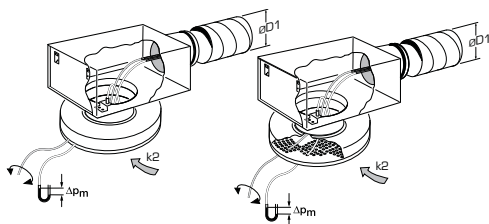

ØD1	k2
100	16,8
125	24,9
160	31,1
200	44,1

KH

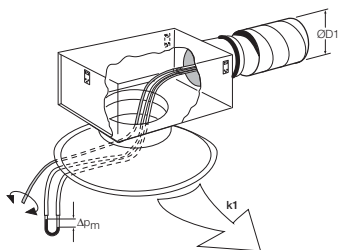

03.2001
lähtien

03.2003
lähtien



Koko	ød	øD	k1	k1	k1
100	100	100	7.40	7.40	7.40
125	100	125	7.40	7.40	7.40
125	125	125	13.0	13.0	13.0
160	125	160	13.0	13.0	13.0
160	160	160	25.3	21.5	15.9
200	160	200	25.3	21.5	15.9
200	200	200	38.0	36.0	24.5
250	200	250	38.0	36.0	24.5
250	250	250	63.5	63.5	37.7
315	250	315	63.5	63.5	37.7
315	315	315	97.0	97.0	64.8
400	315	400	97.0	97.0	64.8

KH + ATTB

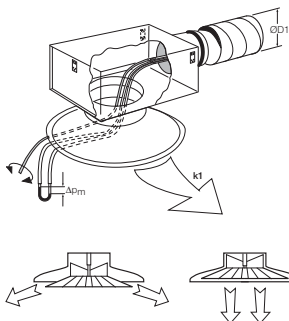

ØD1	ØØD1	1-7ØD1	>7ØD1
100	6,7	7,0	6,3
125	10,6	11,7	10,7
160	17,6	20,0	18,5
200	26,9	31,6	29,2
250	44,8	50,5	46,7
250 *	40,9	43,2	38,8
315	75,0	80,0	80,0
315 *	64,4	63,2	66,4

* 08.03.2010 lähtien

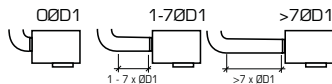

KHD + ATTB

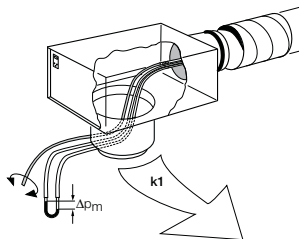

KHD	ØD1	ØØD1	1-7ØD1	>7ØD1
200	160	17,6	20,0	18,5
250	200	26,9	31,6	29,2
315	250	44,8	50,5	46,7
400	315	75,0	80,0	80,0
500	-	-	-	-

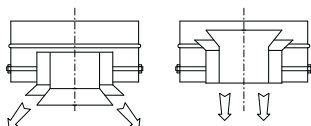

Ø200-Ø250

Ø315-Ø500

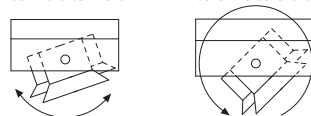

ØØD1

1-7ØD1

>7ØD1

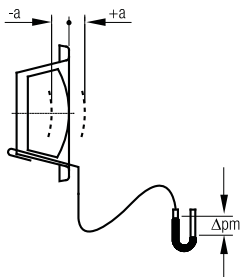

KS

KS-100	
Avaus a	k
-9	0.6
-6	0.75
-3	0.95
0	1.2
3	1.45
6	1.75
9	2.0
12	2.2

KS-125	
Avaus a	k
-12	1.7
-9	1.95
-6	2.25
-3	2.7
0	2.95
6	3.8
9	4.25

KS-150	
Avaus a	k
-12	2.3
-6	2.9
0	3.9
6	5.0
12	6.4

KS-160	
Avaus a	k
-12	1.4
-9	1.8
-6	2.3
-3	2.8
0	3.3
3	3.8
6	4.2

KSO-M, KSO-MH

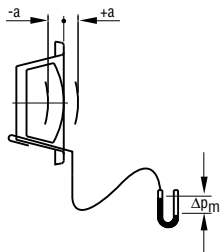

ø100 a	k
-15	0,5
-12	0,8
-10	1,0
-5	1,4
0	1,9
5	2,3
10	2,8

ø125 a	k
-15	0,6
-12	1,1
-10	1,5
-5	2,1
0	2,7
5	3,3
10	4,0

KSO-M-100

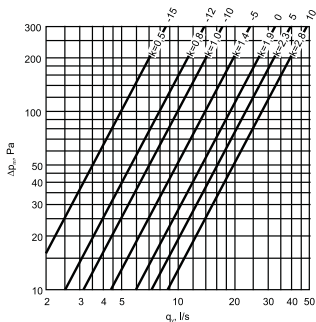

KSO-M-125

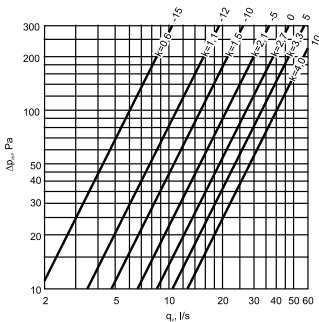

KSOP / KSO-P

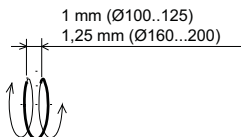
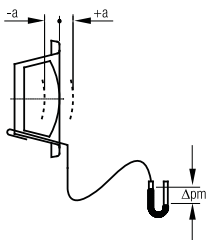

Ø100 a	k
-15	0,5
-12	0,8
-10	1,0
-5	1,4
0	1,9
5	2,3
10	2,8

Ø125 a	k
-10	1,5
-5	2,1
0	2,7
5	3,3
10	4,0

Ø160 a	k
-10	2,0
-5	2,8
0	3,6
5	4,4
10	5,3
15	6,2

Ø200 a	k
-3	1,8
0	2,4
5	3,8
10	5,0
15	6,3
20	7,5
25	8,6

KVM

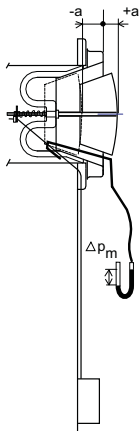

KVM-100	
Avaus a	k
-15	0.5
-12	0.8
-10	1.0
-5	1.4
0	1.9
5	2.3
10	2.8

KVM-125	
Avaus a	k
-10	1.5
-5	2.1
0	2.7
5	3.3
10	4.0

NWPPlus

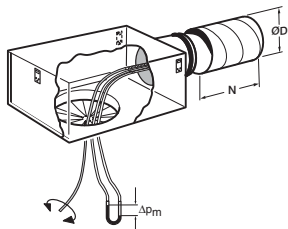

ØD, mm	k	Nmin, mm
125	13,0	500
160	25,3	500
200	38,0	500
250	63,5	750
315	97,0	750

RHKB, RHOB (RHKH, RHOH + ATTB)

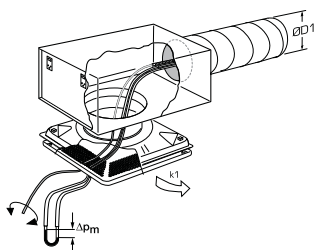

ØD1	0ØD1	1-7ØD1	>7ØD1
100	6,7	7,0	6,3
125	10,6	11,7	10,7
160	17,6	20,0	18,5
200	26,9	31,6	29,2
250	40,9	43,2	38,8
315	64,4	63,2	66,4

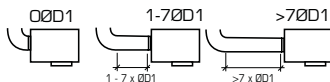

RHU

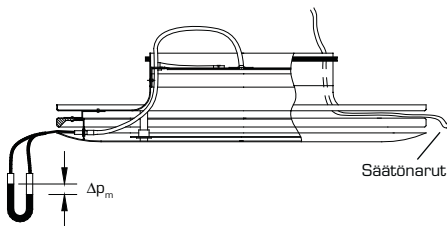

RHU	Narujen väri		k
	Sulkeva	Avaava	
100	Puna-valkoinen	valk.	5,9
125	Musta-valkoinen	valk.	15,0
160	Oranssi-valkoinen	valk.	15,0
200	Sini-valkoinen	valk.	24,4
250	Vihreä-valkoinen	valk.	24,4

ROFA, RPFA

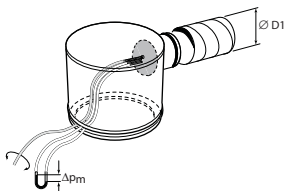

$\varnothing D1$	$0\varnothing D1$	$1-7\varnothing D1$	$>7\varnothing D1$
100	6,7	7,0	6,3
125	10,6	11,7	10,7
160	17,6	20,0	18,5
200	26,9	31,6	29,2
250	44,8	50,5	46,7
250 *	40,9	43,2	38,8
315	75,0	80,0	80,0
315 *	64,4	63,2	66,4

* 08.03.2010 lähtien

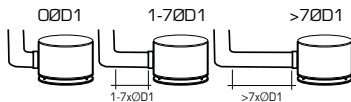

ROKA, RPKA + ATTB

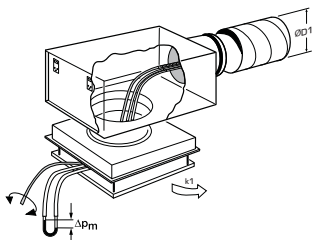

$\varnothing D1$	$0\varnothing D1$	$1-7\varnothing D1$	$>7\varnothing D1$
100	6,7	7,0	6,3
125	10,6	11,7	10,7
160	17,6	20,0	18,5
200	26,9	31,6	29,2
250	44,8	50,5	46,7
315	75,0	80,0	80,0

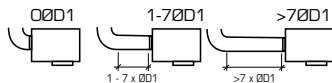

RORB, RPRB (RORH, RPRH + ATTC)

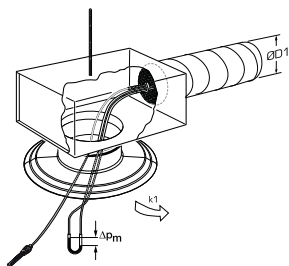

$\varnothing D1$	$0\varnothing D1$	$1-7\varnothing D1$	$>7\varnothing D1$
100	6,0	6,3	5,9
125	10,1	10,6	10,1
160	17,1	19,9	17,3
200	27,0	30,8	27,9
250	47,1	48,8	39,9
315	65,9	67,2	64,1

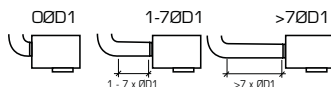

ROSA, RPSA + ATTB

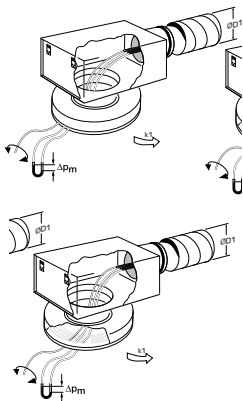

$\varnothing D1$	$0\varnothing D1$	$1-7\varnothing D1$	$>7\varnothing D1$
100	6,7	7,0	6,3
125	10,6	11,7	10,7
160	17,6	20,0	18,5
200	26,9	31,6	29,2
250	44,8	50,5	46,7
315	75,0	80,0	80,0

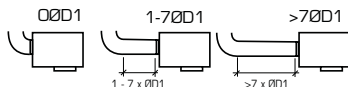

RSKO, RSKP + ATTB

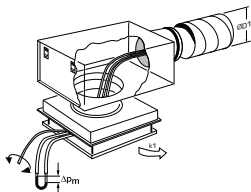

ØD1	0ØD1	1-7ØD1	>7ØD1
100	6,7	7,0	6,3
125	10,6	11,7	10,7
160	17,6	20,0	18,5
200	26,9	31,6	29,2
250	44,8	50,5	46,7
315	75,0	80,0	80,0

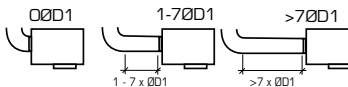

RSRO, RSRP + ATTB

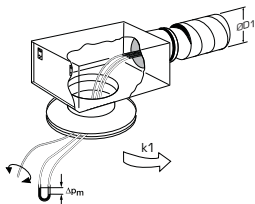

ØD1	0ØD1	1-7ØD1	>7ØD1
100	6,7	7,0	6,3
125	10,6	11,7	10,7
160	17,6	20,0	18,5
200	26,9	31,6	29,2
250	44,8	50,5	46,7
250 *	40,9	43,2	38,8
315	75,0	80,0	80,0
315 *	64,4	63,2	66,4

* 08.03.2010 lähtien

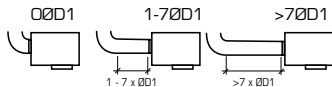

SDZA

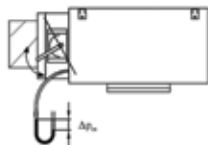

Ilmavirta mitataan ilmavirransäätimellä ja säädetään kanavapellillä tai vaihtoehtoisesti liitoslaatikossa olevalla kanavapellillä.

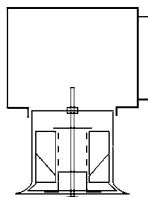

SDZA ilman liitântälaatikkoa

SDZA	k
315	37,3
400	58,9
500	79,0
630	133,4
710	169,3

SE

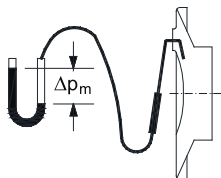

SE-100 Reikiä auki	k
3	1.1
4	1.3
5	1.5
6	1.6
7	1.9

SE-125 Reikiä auki	k
3	1.7
4	2.2
5	2.6
6	3.1
7	3.3

STH

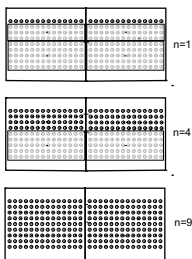
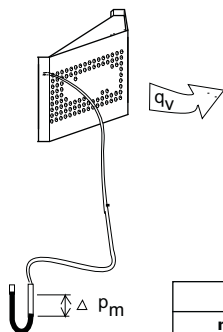

n	k	
	100	125
1	0,7	0,9
2	1,1	1,5
3	1,4	2,1
4	1,8	2,8
5	2,2	3,5
6	2,6	4,2
7	3,1	5,1
8	3,4	5,8
9	3,8	6,4

STH-100

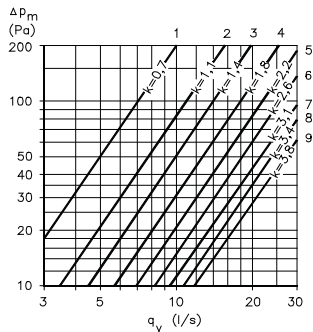

STH-125

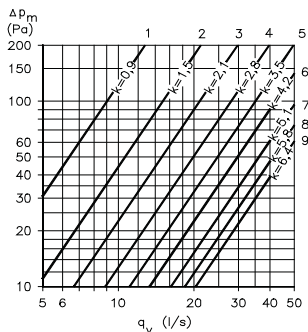

SVB säätöaruilla

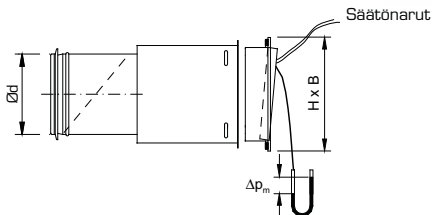

SVB-	H x B	k	
		Etulevy	
		auki	kiinni
80	125 x 320	3,7	3,2
100	175 x 420	4,9	4,4
125	175 x 520	7,0	6,4
160	225 x 620	10,4	8,9
200	245 x 820	14,0	12,5

SVE

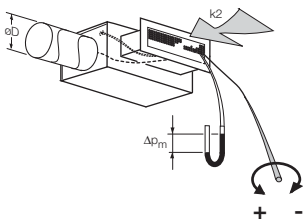

Koko	B x H	k2	
		s = 30 mm	s = 0 mm
100	366 x 128	9.30	7.0
125	516 x 128	15.2	11.8
160	616 x 128	20.1	18.0
200	716 x 178	44.6	34.1

SVQ

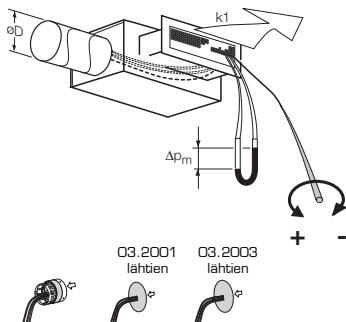

ØD	B x H	k1	k1	k1
100	366 x 128	7.40	7.40	7.40
125	516 x 128	13.0	13.0	13.0
160	616 x 128	25.3	21.5	15.9
200	716 x 178	38.0	36.0	24.5

SVQ säätöaruilla

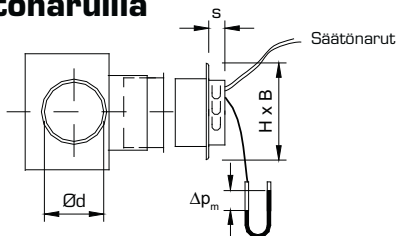

SVQ-	H x B	k	
		Etulevyn säätö	
		s = 30 mm	s = 0 mm
100	125 x 367	6,8	5,8
125	126 x 517	11,8	9,7
160	126 x 617	16,2	14,4
200	176 x 717	27,1	24,7

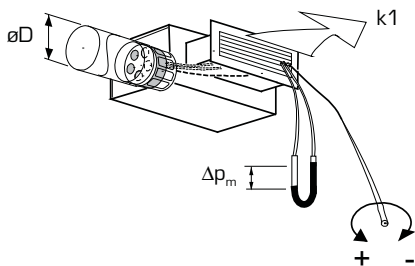

B x H	ØD	k1		
		3.2001 asti	3.01 - 2.03	3.03 - 9.11
200x100	125	13,0	13,0	13,0
300x100	160	25,3	21,5	15,9
400x100	160	25,3	21,5	15,9
500x100	200	38,0	36,0	24,5
600x100	250	63,5	63,5	37,7
800x100	250	63,5	63,5	37,7
1000x100	250	63,5	63,5	37,7
300x150	200	38,0	36,0	24,5
400x150	250	63,5	63,5	37,7
500x150	250	63,5	63,5	37,7
600x150	250	63,5	63,5	37,7
800x150	315	97,0	97,0	64,8
1000x150	315	97,0	97,0	64,8
400x200	250	63,5	63,5	37,7
500x200	315	97,0	97,0	64,8
600x200	315	97,0	97,0	64,8
800x200	315	97,0	97,0	64,8
1000x200	315	97,0	97,0	64,8

VFFA

10/2011 lähtien

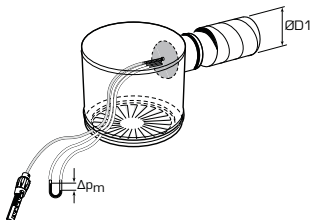

$\varnothing D1$	0$\varnothing D1$	1-7$\varnothing D1$	>7$\varnothing D1$
100	6,0	6,3	5,9
125	10,1	10,6	10,1
160	17,1	19,9	17,3
200	27,0	30,8	27,9
250	47,1	48,8	39,9
315	65,9	67,2	64,1

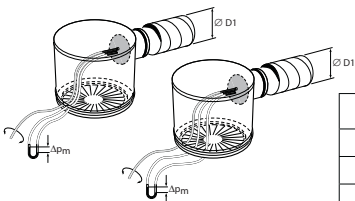
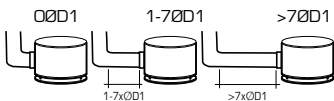

$\varnothing D1$	0$\varnothing D1$	1-7$\varnothing D1$	>7$\varnothing D1$
100	6,7	7,0	6,3
125	10,6	11,7	10,7
160	17,6	20,0	18,5
200	26,9	31,6	29,2
250	44,8	50,5	46,7
250 *	40,9	43,2	38,8
315	75,0	80,0	80,0
315 *	64,4	63,2	66,4

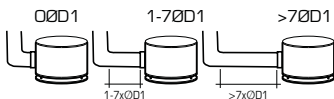

* 08.03.2010 lähtien

VFKA + ATTB

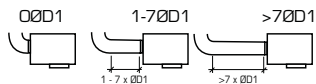
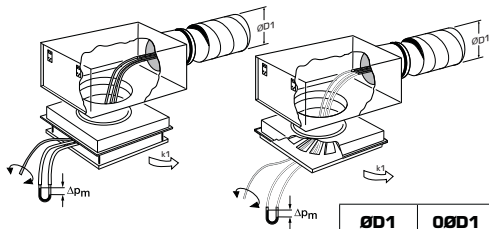

ØD1	0ØD1	$1-7\text{ØD1}$	$>7\text{ØD1}$
100	6,7	7,0	6,3
125	10,6	11,7	10,7
160	17,6	20,0	18,5
200	26,9	31,6	29,2
250	44,8	50,5	46,7
315	75,0	80,0	80,0

VFKB (VFKH + ATTB)

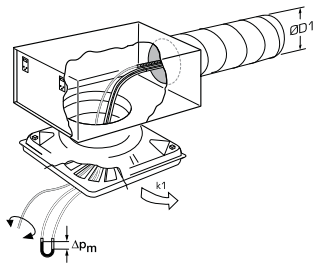

ØD1	0ØD1	$1-7\text{ØD1}$	$>7\text{ØD1}$
100	6,7	7,0	6,3
125	10,6	11,7	10,7
160	17,6	20,0	18,5
200	26,9	31,6	29,2
250	40,9	43,2	38,8
315	64,4	63,2	66,4

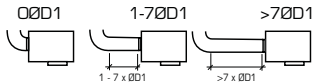

VFSA + ATTB

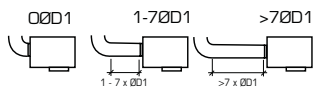
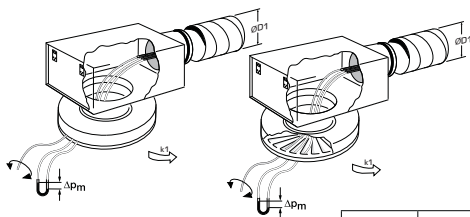

ØD1	0ØD1	1-7ØD1	>7ØD1
100	6,7	7,0	6,3
125	10,6	11,7	10,7
160	17,6	20,0	18,5
200	26,9	31,6	29,2
250	44,8	50,5	46,7
315	75,0	80,0	80,0

VSKA + ATTB

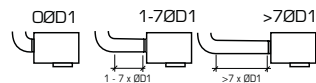
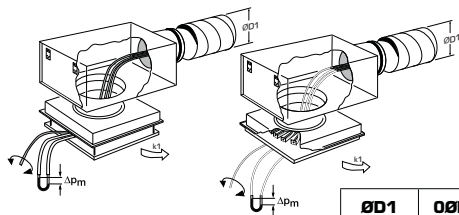

ØD1	0ØD1	1-7ØD1	>7ØD1
100	6,7	7,0	6,3
125	10,6	11,7	10,7
160	17,6	20,0	18,5
200	26,9	31,6	29,2
250	44,8	50,5	46,7
315	75,0	80,0	80,0

VSFA

10/2011 lähtien

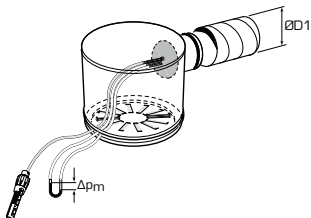

ØD1	0ØD1	1-7ØD1	>7ØD1
100	6,0	6,3	5,9
125	10,1	10,6	10,1
160	17,1	19,9	17,3
200	27,0	30,8	27,9
250	47,1	48,8	39,9
315	65,9	67,2	64,1

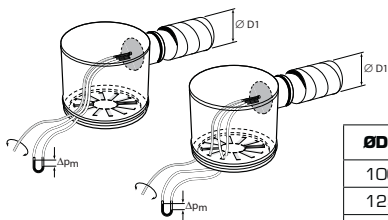
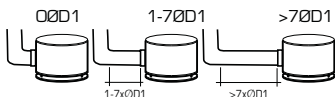

ØD1	0ØD1	1-7ØD1	>7ØD1
100	6,7	7,0	6,3
125	10,6	11,7	10,7
160	17,6	20,0	18,5
200	26,9	31,6	29,2
250	44,8	50,5	46,7
250 *	40,9	43,2	38,8
315	75,0	80,0	80,0
315 *	64,4	63,2	66,4

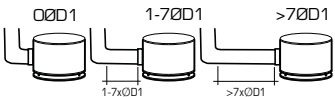

* 08.03.2010 lähtien

VSKB (VSKH + ATTB)

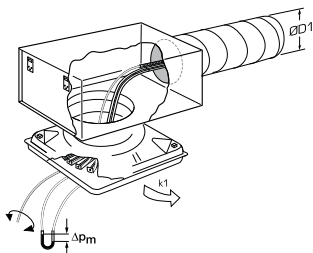

ØD1	0ØD1	1-7ØD1	>7ØD1
100	6,7	7,0	6,3
125	10,6	11,7	10,7
160	17,6	20,0	18,5
200	26,9	31,6	29,2
250	40,9	43,2	38,8
315	64,4	63,2	66,4

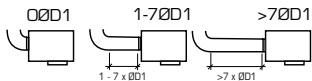

VSSA + ATTB

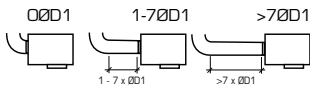
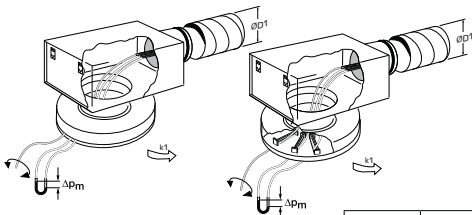

ØD1	0ØD1	1-7ØD1	>7ØD1
100	6,7	7,0	6,3
125	10,6	11,7	10,7
160	17,6	20,0	18,5
200	26,9	31,6	29,2
250	44,8	50,5	46,7
315	75,0	80,0	80,0

Varimix ATTA/ATFA tasauslaatikolla

CTDK (CTDA)
 CTDL (CTDB)
 CTEK (CTEA)
 CTEL (CTEB)

RHRO = RSRO + ATTA
 RHRP = RSRP + ATTA
 RHKO = RSKO + ATTA
 RHKP = RSKP + ATTA

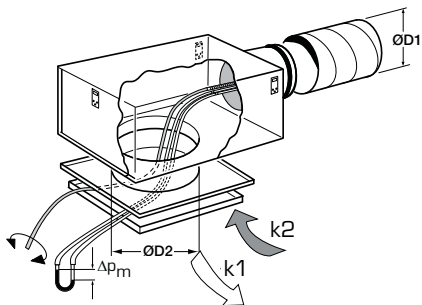

DTTZ 09.1996 lähtien		ATTA 03.2001 03.2003 lähtien lähtien		ATFA	
ØD1	k1	k1	k1	ØD2	k2 ¹⁾
100	7.4	7.4	7.4	125	-
125	13.0	13.0	13.0	160	12.2
160	25.3	21.5	15.9	200	19.7
200	38.0	36.0	24.5	250	26.0
250	63.5	63.5	37.7	315	31.5
315	97.0	97.0	64.8	400	46.0

¹⁾ Nämä arvot pätevät 25 mm:n nimellisraolla.

Varimix

jossa mittaus tasauslaatikossa DTTZ

(toimitettu 09.1996 alkaen)

RHRO = RSRO + DTTZ
RHRP = RSRP + DTTZ

RHKO = RSKO + DTTZ
RHKP = RSKP + DTTZ

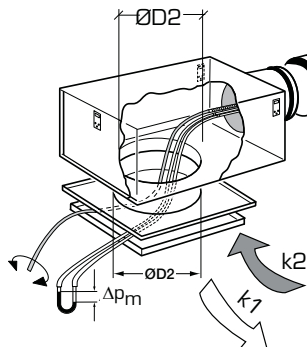



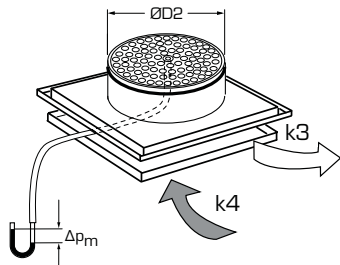

ØD1	k1	k1	ØD2	k2
100	7.40	7.40	125	-
125	13.0	13.0	160	22.5
160	25.3	21.5	200	33.7
200	38.0	36.0	250	52.0
250	63.5	63.5	315	74.6
315	97.0	97.0	400	97.0

Varimix jossa mittaus laitteessa

CTDA, CTDB, CTEA, CTEB



	ØD2	 k3	 k3	 k3	 k3	 k4
CTDA	125	6.50	7.60	7.50	7.80	-
	160	8.90	10.7	11.3	12.4	-
	200	13.7	16.9	16.1	17.4	-
	250	18.2	22.4	21.4	23.4	-
	315	25.9	32.4	29.7	34.5	-
	400	-	38.2	34.2	40.1	-
CTDB	125	5.90	6.50	6.80	7.10	6.40
	160	7.70	9.40	9.80	10.5	9.90
	200	13.2	16.9	15.5	17.6	14.6
	250	19.0	23.8	21.4	25.0	20.0
	315	24.8	31.8	28.5	34.2	33.0
	400	-	39.8	30.0	41.3	53.2
CTEA	125	6.90	7.90	7.90	8.30	-
	160	10.4	12.9	13.2	14.1	-
	200	13.7	16.9	16.1	17.4	-
	250	19.0	22.5	21.3	24.6	-
	315	26.6	33.6	31.2	36.4	-
	400	-	43.6	37.8	45.7	-
CTEB	125	6.60	7.30	7.50	7.80	6.40
	160	10.0	11.6	12.3	13.1	9.90
	200	12.4	15.9	15.2	16.6	14.6
	250	16.8	22.0	19.9	23.9	20.0
	315	27.5	31.0	30.2	36.4	33.0
	400	-	38.8	36.6	44.6	53.2

EMA(S,E)

toimitettu ennen 05/2014 (EMAS/EMAE-1) ja ennen 08/2015 (EMAS/EMAE-5)

Koko	100	125	160	200	250	315	400	500	630
Ilmavirtasäädin									
EMAS, EMAE	4,0	6,0	10	16	25	40	64	-	-

EHO(S,E)

Koko	100	125	160	200	250	315	400	500	630
Ilmavirtasäädin									
EHOS, EHOE	5,6	11	20	32	52	77	121	-	-

EMO(S,E), EMS(S,D)

20.06.2008 alkaen

Koko	100	125	160	200	250	315	400	500	630
Ilmavirtasäädin									
EMOS, EMOE	4,0	6,0	10	16	25	40	64	-	-
EMSS, EMSD	4,0	6,0	10	16	25	40	64	98	152

EMOE, EMOS, EMSS, EMSD, EMSF

(toimitettu ennen 20.06.2008)

Koko	100	125	160	200	250	315	400	500	630
Ilmavirtasäädin									
EMOE, EMOS	5,18	10,0	19,0	31,0	46,0	75,0	117	-	-
EMSS, EMSD	5,18	10,0	19,0	31,0	46,0	75,0	117	171	240
Mittalaite									
EMSF	5,18	10,0	19,0	31,0	46,0	75,0	117	171	240

Säätö- ja mittalaitteet, EMSM, EM(J,P)(B,C), EMJT, EMJF

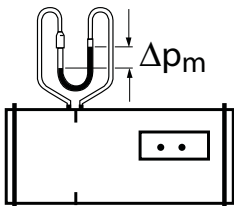

**EMSM, EMSF,
EMSS, EMSD**

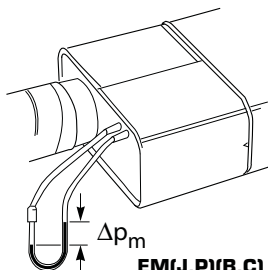

**EM(J,P)(B,C)
EMJT, EMJF
EMOE, EMOS**

Koko	080	100	125	160	200	250	315	400	500
Säätö- ja mittalaite EMSM	-	5.18	10.0	18.9	32.9	52.1	90.8	142	224
Ilmavirtasäädin EM(J,P)(B,C)	-	5.18	10.0	18.9	32.9	52.1	90.8	142	-
EMJ(T.F)	-	3.70	5.90	10.7	19.5	34.5	64.8	117	-

EHCA, EHCB

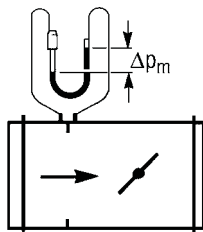

Koko Ilmavirtasäädin	008	010	012	016	020	025	031	040	050
EHC(A,B)	2.54	5.18	10.0	18.9	32.9	52.1	90.8	142	224

IQIB/IQIC

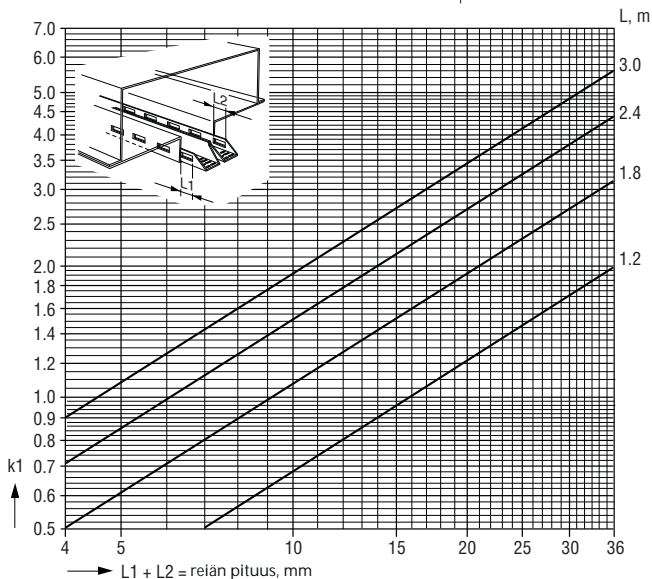
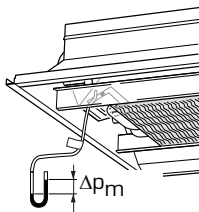
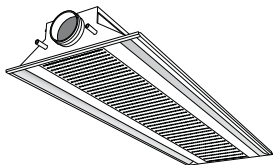

QTSB (QTSS)

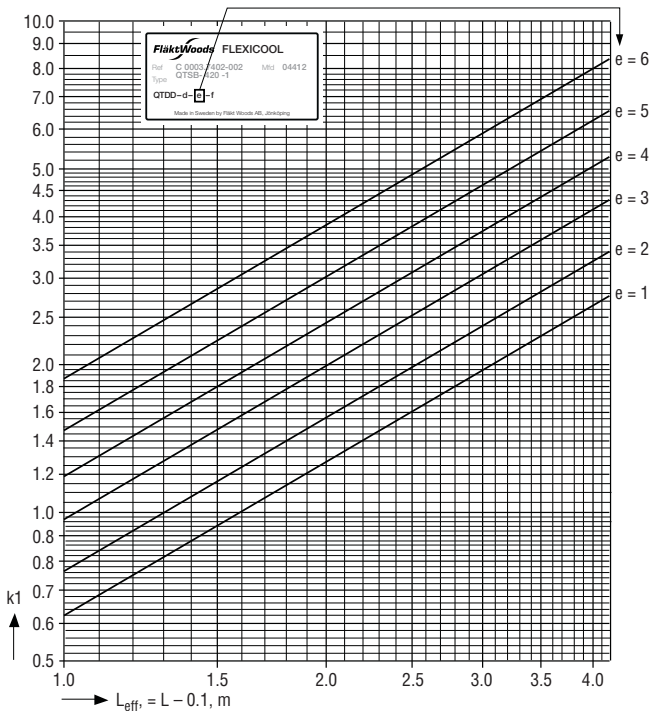
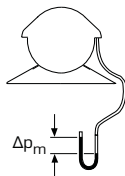
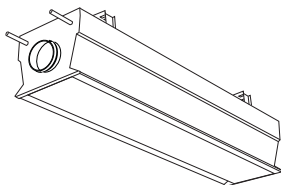

IRIS-M

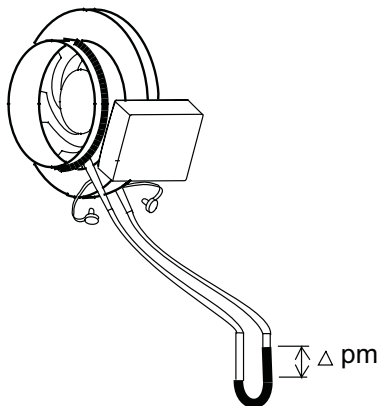

Ø	a								
	1	2	3	4	5	6	7	8	min
100	10,4	7,5	6,0	4,5	3,4	2,5	1,7	0,9	0,2
125	13,8	8,8	6,5	4,7	3,5	2,7	1,5	0,9	0,5
160	22,1	14,8	12,5	10,7	8,5	6,8	4,9	3,5	2,1
200	44,2	30,9	23,2	18,2	14,0	11,0	8,4	5,0	1,1
250	64,4	45,6	38,7	30,7	24,1	18,4	12,8	8,9	3,2
315	118,0	70,0	58,7	45,1	37,0	30,0	21,8	15,8	10,3

Ø	a							
	1,5	2,5	3,5	4,5	5,5	6,5	7,5	8,5
100	7,9	6,6	5,2	3,8	2,9	2,1	1,2	0,4
125	10,4	7,3	5,5	4,0	3,1	2,2	1,0	-
160	17,2	13,4	11,5	9,5	7,5	5,6	4,0	2,6
200	36,6	26,9	20,6	15,9	12,3	9,6	6,5	3,0
250	53,5	41,8	34,5	27,3	21,4	15,8	10,9	6,1
315	88,3	64,5	53,0	42,4	33,3	25,9	19,0	12,9

IRIS-M-100

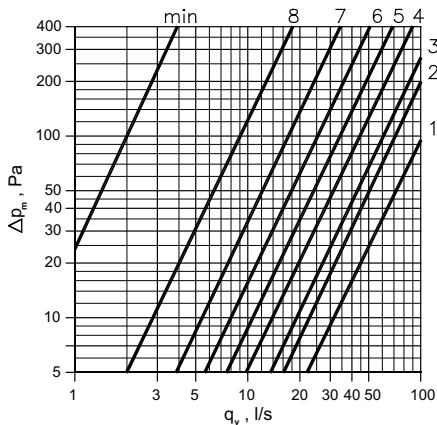

IRIS-M-125

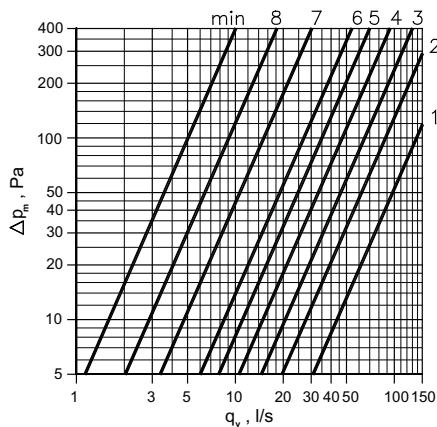

IRIS-M-160

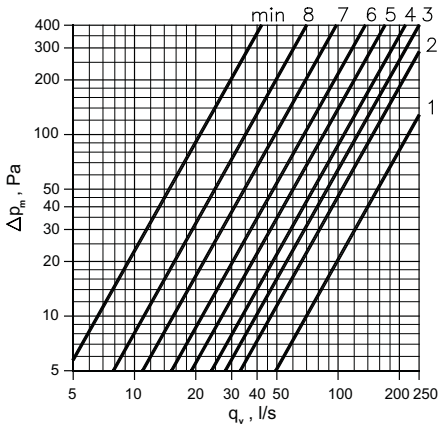

IRIS-M-200

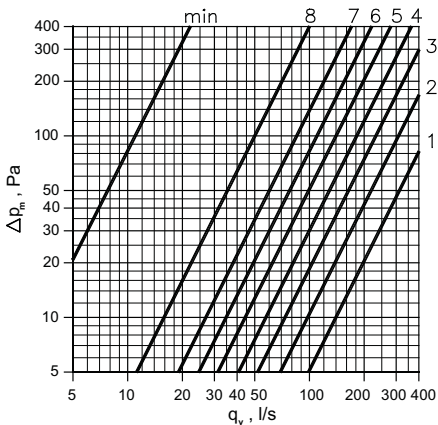

IRIS-M-250

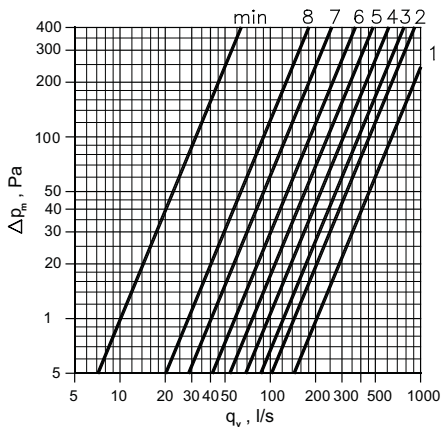

IRIS-M-315

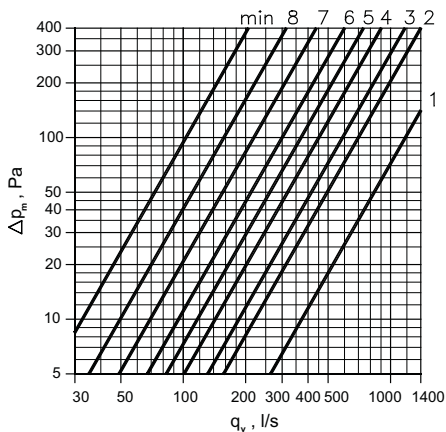

MRS

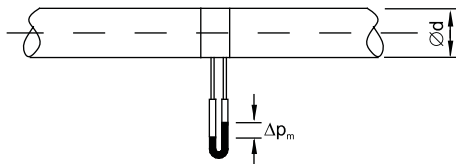

MRS	k
100	4,0
125	7,4
160	13,6
200	23,4
250	40
315	66



WE BRING
BETTER AIR™
TO LIFE

WWW.FLAKTWOODS.FI

MS-OPAS | 4989FI | 20150414

FWG-ilmavirtojen mitaus- ja säätöopas-2015.04.4989FI
Oikeudet muutoksiin pidätetään.